

Mitas

AGRICULTURAL TIRES

Technical manual



Mitas

Application

Application	Product category	Tread pattern	Page
Tractors	Tractor radial tires	HC 2000 – VF series	18
		HC 1000 – VF series	24
		SFT – Super Flexion Tire	28
		SST – Silent Speed Tire	40
		AC 65 – 65 series	44
		HC 70 – 70 series	52
		AC 70 T – 70 series	58
		AC 70 G – 70 series	66
		AC 85 – standard	70
	Tractor diagonal tires	TD – Tractor Drive	170
	Tractor front tires	TF – Tractor Front	206
Harvesters	Harvester tires – drive wheel	HC 3000 – VF series	90
		CHO	94
		SFT harvester	100
		AC 70 H/G/N	100
		Harvester tires – steering wheel	SFT, AC 70 G, AC 65 IMP
Transport equipment	Trailer radial tires	Agriterra 02, 02 SP, 03 & 04	124
		AR – Agricultural Radial	132
	Grain cart tires	HC 3000 – VF series	90
		CHO	94
		SFT harvester	100
		AC 70 H/G/N	100
	Trailer diagonal tires	IM series	180
TR series		190	
Sprayers & Spreaders	Sprayer radial tires	HC 1000 – VF series	24
		AC 85 / AC 90 – Row Crop	80
	Spreader radial tires	HC 3000 – VF series	90
		CHO	94
		SFT harvester	100
	AC 70 H/G/N	100	
Crop processing and green area equipment	Implement non traction tires	IM & B series	180
	Implement traction tires	TR series	190
	Tractor small tires	TS & B series	198
	Bantam tires	Bantam series	211
Agro-industrial equipment	Municipal radial tires	HCM – High Capacity Municipal radial	138
	Agro-industrial radial tires	TI series & AC 70 G (IND)	144
	Agro-industrial multipurpose radial tires	AC 70 G (MPT) & AC 70+	148
	Agro-industrial diagonal tires	MPT-01, TD-10 (MPT), TR-01 & TI-05	156
Forestry equipment	Agro-forestry tires	AF series	166

Contents

Tread patterns, markings and definitions

List of tread patterns	4
List of tire sizes	6
Tire size marking	10
Speed symbols and conversion tables	11
Tire sidewall marking and structures	12
Load index	13
Main applications chart	14

Tractor radial tires

HC 2000 – VF tire (Very High Flexion)	16
HC 1000 – VF tire (Very High Flexion)	22
SFT – Super Flexion Tire	26
SST – Silent Speed Tire	38
AC 65 – 65 series	42
HC 70 – 70 series	50
AC 70 T – 70 series	56
AC 70 G – 70 series	64
AC 85 – standard	68
AC 85 / AC 90 – Row Crop	78

Harvester radial tires

HC 3000 - VF tire, CFO series – drive wheel	88
CHO – drive wheel	92
SFT & AC 70 H/G/N – drive wheel	98
SFT, AC 70 G, AC 65 IMP – steering wheel	108
Conversion table – tractor and harvester radial tires	118

Trailer radial tires

Agriterra 02, 02 SP, 03 & 04	122
AR – Agricultural radial	130

Municipal, Agro-industrial and Multipurpose tires

HCM – High Capacity Municipal radial	136
Ti-20 – Agro-industrial radial	142
AC 70 G & MPT-21 – Multipurpose radial (MPT)	146
Agro-industrial diagonal	154

Tractor diagonal tires

AF – Tractor Agro-forestry	164
TD – Tractor diagonal	168

Implement diagonal tires

IM – Implement non traction	178
TR – Implement traction	188

Other tires

TS & B – Tractor small	196
TF – Tractor front	204
B & V – Bantam	210

U.S. Tread pattern marking	212
Use and maintenance	213
Fitting and removal instructions	214
Liquid ballasting of tractor tires	215
Explanations referring to tractor tires	220
Explanations referring to IMP tires	222
Terms and abbreviations used in this catalogue	224

Tread patterns





IM-02

IM-03

IM-04

IM-07

IM-09

IM-10



AC 30

G 1

B 3

B 19

B 63

TR-01



TR-03

TR-04

TR-05

TR-06

TR-07

TR-08



TR-10

TR-11

TR-12

TS-02

TS-04

TS-05



TS-06

TS-07

B 12

B 16

B 17

B 18



B 64

TF-01

TF-02

TF-03

TF-04

IM-05



B 11

B 15

V-5501

V-5501A

Tractor radial tires Page 16

Harvester radial tires Page 88

Trailer radial tires Page 122

Agro-industrial tires Page 136

Tractor diagonal tires Page 164

Diagonal tires Page 178

List of tire sizes

Size (inch)	Tire size (Alternative tire size)	Tread pattern	Page	
Tractor & Harvester radial				
16"	200/70 R 16	AC 70 T	58	
	240/70 R 16	AC 70 T	58	
	260/70 R 16	AC 70 T	58	
	280/70 R 16	AC 70 T	58	
	320/65 R 16	AC 65	44	
18"	280/70 R 18	AC 70 T	58	
	260/70 R 20	AC 70 T	58	
20"	280/70 R 20	AC 70 T	58	
	280/85 R 20 (11.2 R 20)	AC 85	70	
	300/70 R 20	AC 70 T	58	
	320/70 R 20	AC 70 T	58	
	320/85 R 20 (12.4 R 20)	AC 85	70	
	360/70 R 20	AC 70 T	58	
	380/70 R 20	AC 70 T	60	
	420/65 R 20	AC 65 N	44	
	420/65 R 20	AC 65	44	
	24"	280/85 R 24 (11.2 R 24)	AC 85	70
		320/70 R 24	HC 70	52
		320/70 R 24	AC 70 T	60
		320/85 R 24 (12.4 R 24)	AC 85	70
		340/85 R 24 (13.6 R 24)	AC 85	70
		360/70 R 24	HC 70	52
360/70 R 24		AC 70 T	60	
380/70 R 24		HC 70	52	
380/70 R 24		AC 70 T	60	
380/70 R 24		AC 70 G	66	
380/85 R 24 (14.9 R 24)		AC 85	70	
420/70 R 24		HC 70	52	
420/70 R 24		AC 70 T	60	
420/70 R 24		AC 70 G	66	
420/85 R 24 (16.9 R 24)		AC 85	70	
440/65 R 24	AC 65	44		
460/70 R 24 IMP	AC 70 G	110		
480/65 R 24	AC 65	44		
480/70 R 24	HC 70	52		
480/70 R 24	AC 70 G	66		
500/70 R 24 IMP	AC 70 G	110		
500/85 R 24 IMP	SFT	110		
540/65 R 24	AC 65	44		
25"	1000/50 R 25	SFT	28, 100	
26"	620/55 R 26 IMP	SFT	110	
	620/75 R 26	SFT	28, 100	
	VF 750/65 R 26 CFO	HC 3000	90	
	750/65 R 26	SFT	28	
28"	280/85 R 28 (11.2 R 28)	AC 85	70	
	320/85 R 28 (12.4 R 28)	AC 85	70	
	340/85 R 28 (13.6 R 28)	AC 85	70	
	380/70 R 28	HC 70	52	
	380/70 R 28	AC 70 T	60	
	380/85 R 28 (14.9 R 28)	AC 85	72	
	420/70 R 28	HC 70	52	
	420/70 R 28	AC 70 T	60	
	420/70 R 28	AC 70 G	66	
	VF 420/85 R 28 (16.9 R 28)	HC 2000	18	
	420/85 R 28 (16.9 R 28)	AC 85	72	

Size (inch)	Tire size (Alternative tire size)	Tread pattern	Page
	440/65 R 28	AC 65	44
	480/65 R 28	AC 65	46
	480/70 R 28	HC 70	52
	480/70 R 28	AC 70 T	60
	500/80 R 28 IMP	SFT	110
	540/65 R 28	SFT	28
	540/65 R 28	AC 65	46
	600/65 R 28	SFT	28
	600/65 R 28	AC 65	46
	600/65 R 28 IMP	AC 65	112
	600/70 R 28	SFT	28
30"	380/85 R 30 (14.9 R 30)	AC 85	72
	420/70 R 30	HC 70	52
	420/70 R 30	AC 70 T	60
	420/85 R 30 (16.9 R 30)	AC 85	72
	420/90 R 30	AC 85	72
	460/85 R 30 (18.4 R 30)	AC 85	72
	480/70 R 30	HC 70	54
	480/70 R 30	AC 70 T	60
	480/70 R 30	AC 70 G	66
	500/85 R 30 IMP	SFT	112
	500/85 R 30 IMP	SFT N	112
	VF 540/65 R 30	HC 2000	18
	540/65 R 30	SFT	28
	540/65 R 30	AC 65	46
	540/65 R 30 IMP	AC 65	114
600/65 R 30	AC 65	46	
VF 600/70 R 30	HC 2000	18	
600/70 R 30	SFT	30	
620/70 R 30 IMP	SFT	114	
620/70 R 30 IMP	SFT N	114	
620/75 R 30	SFT	30, 100	
620/75 R 30 IMP	SFT	114	
710/55 R 30	SFT	30	
710/60 R 30	SFT	30	
710/60 R 30 IMP	SFT	114	
710/65 R 30 IMP	SFT	114	
750/55 R 30	SFT	30	
32"	270/80 R 32	AC 90	80
	270/95 R 32	AC 85	80
	320/85 R 32 (12.4 R 32)	AC 85	80
	320/90 R 32	AC 85	80
	IF 650/75 R 32 CFO	AC 70 G	100
	650/75 R 32	AC 75 H	100
	650/75 R 32	AC 75 G	100
	650/75 R 32	AC 70 G	102
	680/85 R 32 CHO	AC 70 G	94
	680/85 R 32	AC 70 G	102
800/65 R 32	AC 70 H	102	
800/65 R 32	AC 70 N	102	
800/70 R 32 CHO	SFT	94	
800/70 R 32	SFT	30, 102	
900/60 R 32 CHO	SFT	94	
900/60 R 32	SFT	30, 102	
900/70 R 32 CHO	SFT	94	
900/70 R 32	SFT	30, 104	

Size (inch)	Tire size (Alternative tire size)	Tread pattern	Page
	VF 1000/65 R 32 CFO	HC 3000 R	90
	1050/50 R 32 CHO	SFT	94
	1050/50 R 32	SFT	32, 104
	1250/50 R 32 CHO	SFT	94
	1250/50 R 32	SFT	32, 104
34"	320/85 R 34	AC 85	80
	VF 380/85 R 34 (14.9 R 34)	HC 2000	18
	380/85 R 34 (14.9 R 34)	AC 85	72
	VF 420/85 R 34 (16.9 R 34)	HC 2000	18
	420/85 R 34 (16.9 R 34)	AC 85	72
	460/85 R 34 (18.4 R 34)	AC 85	72
	480/70 R 34	HC 70	54
	480/70 R 34	AC 70 T	62
	480/70 R 34	AC 70 G	66
	500/85 R 34 IMP	SFT	116
	500/85 R 34 IMP	SFT N	116
	520/70 R 34	HC 70	54
	520/70 R 34	AC 70 T	62
	520/70 R 34	AC 70 G	66
	VF 540/65 R 34	HC 2000	18
	540/65 R 34	AC 65	46
	VF 580/80 R 34 CFO	HC 3000	90
	600/65 R 34	AC 65	46
	650/60 R 34	SFT	32
	650/65 R 34	SFT	32
	710/60 R 34	SFT	32
36"	270/80 R 36	AC 90	80
	13.6 R 36	AC 90	82
38"	320/85 R 38 (12.4 R 38)	AC 85	82
	340/85 R 38 (13.6 R 38)	AC 85	72, 82
	380/80 R 38 (14.9 R 38)	AC 85	74
	VF 380/95 R 38	HC 2000	18
	380/95 R 38	AC 85	74
	420/85 R 38 (16.9 R 38)	AC 85	74
	460/85 R 38 (18.4 R 38)	AC 85	74
	VF 480/70 R 38	HC 2000	18
	480/70 R 38	HC 70	54
	480/70 R 38	AC 70 T	62
	520/70 R 38	HC 70	54
	520/70 R 38	AC 70 T	62
	520/70 R 38	AC 70 G	66
	520/85 R 38 (20.8 R 38)	AC 85	74
	540/65 R 38	AC 65	46
	580/70 R 38	HC 70	54
	580/70 R 38	AC 70 T	62
	600/65 R 38	SST	40
	600/65 R 38	AC 65	48
	VF 650/65 R 38	HC 1000	24
	650/65 R 38	SFT	32
	650/65 R 38	SST	40
	650/65 R 38	AC 65	48, 82
	650/75 R 38	SFT	32
	650/85 R 38	SFT	32
	680/80 R 38 CHO	SFT	94
	710/70 R 38	SFT	34

Size (inch)	Tire size (Alternative tire size)	Tread pattern	Page
	710/70 R 38	SST	40
	710/70 R 38	AC 65	48
	800/70 R 38 CHO	SFT	96
	800/70 R 38	SFT	34
	900/60 R 38 CHO	SFT	96
	900/60 R 38	SFT	34, 104
42"	300/85 R 42 (11.2 R 42)	AC 90	82
	300/95 R 42 (12.4 R 42)	AC 90	82
	IF 320/90 R 42	AC 85	84
	320/90 R 42	AC 85	82
	480/80 R 42	AC 85	74
	VF 520/85 R 42 (20.8 R 42)	HC 2000	18
	VF 520/85 R 42 CFO (20.8 R 42)	HC 3000	90
	520/85 R 42 (20.8 R 42)	AC 85	74
	VF 580/85 R 42 CFO	HC 3000	90
	580/85 R 42	SFT	34, 104
	VF 650/65 R 42	HC 2000	20
	650/65 R 42	SST	40
	650/65 R 42	AC 65	48
	650/75 R 42	SFT	34
	680/80 R 42 CHO	SFT	96
	680/80 R 42	SFT	36, 106
	VF 710/70 R 42	HC 2000	20
	VF 710/70 R 42 CFO	HC 3000	90
	710/70 R 42	SFT	36
	710/70 R 42	SST	40
	710/75 R 42	SFT	36
	710/75 R 42	SST	40
	800/70 R 42 CHO	SFT	96
	IF 900/60 R 42 CFO	SFT	106
	900/60 R 42 CHO	SFT	96
	900/60 R 42	SFT	36
46"	320/95 R 46	AC 85	84
	VF 380/90 R 46	HC 1000	24
	380/90 R 46	AC 85	84
	VF 480/80 R 46	HC 2000	20
	480/80 R 46	AC 85	74
	520/85 R 46 (20.8 R 46)	AC 85	76
	710/65 R 46	SFT	36
	IF 710/65 R 46	SFT	36
	VF 750/60 R 46	HC 1000	24
48"	270/95 R 48	AC 90	84
	340/90 R 48 (13.6 R 48)	AC 85	84
50"	320/90 R 50	AC 85	84
	380/90 R 50	AC 85	76, 86
	VF 380/105 R 50	HC 1000	24
	VF 480/80 R 50	HC 1000	24
	480/80 R 50	AC 85	76
	VF 480/95 R 50	HC 2000	20
	480/95 R 50	AC 85	76
54"	320/90 R 54	AC 85	86
	VF 320/105 R 54	HC 1000	24
	380/90 R 54	AC 85	86
	VF 380/105 R 54	HC 2000	20
	380/105 R 54	AC 85	86

List of tire sizes

Size (inch)	Tire size (Alternative tire size)	Tread pattern	Page
Trailer radial			
17"	440/50 R 17 IMP	AR-04	134
	500/40 R 17 IMP	AR-06	134
	500/50 R 17 IMP	AR-03	134
18"	355/60 R 18 MPT	AR-05	134
	385/65 R 22.5 (15 R 22.5)	AR-01	132
22.5"	445/65 R 22.5 (18 R 22.5)	AR-01	132
	460/65 R 22.5 IMP	AR-01	132
26"	500/60 R 22.5 IMP	AGRITERRA 02	124
	560/45 R 22.5 IMP	AGRITERRA 02	124
	VF 560/60 R 22.5 IMP	AGRITERRA 02 SP	124
	560/60 R 22.5 IMP	AGRITERRA 02	124
	560/60 R 22.5 IMP	AR-02	134
	600/50 R 22.5 IMP	AGRITERRA 02	124
	620/40 R 22.5 IMP	AGRITERRA 02	124
	710/45 R 22.5 IMP	AGRITERRA 02	124
	620/75 R 26 IMP	AGRITERRA 02	126
	600/55 R 26.5 IMP	AGRITERRA 02	126
	650/55 R 26.5 IMP	AGRITERRA 02	126
650/65 R 26.5 IMP	AGRITERRA 02	126	
710/50 R 26.5 IMP	AGRITERRA 02	126	
800/45 R 26.5 IMP	AGRITERRA 02	126	
30.5"	600/60 R 30.5 IMP	AGRITERRA 04	126
	680/60 R 30.5 IMP	AGRITERRA 03	126
	710/50 R 30.5 IMP	AGRITERRA 02	126
32"	750/60 R 30.5 IMP	AGRITERRA 03	128
	850/50 R 30.5 IMP	AGRITERRA 02	128
	800/65 R 32 IMP	AGRITERRA 04	128
Municipal, Agro-industrial radial			
18"	340/80 R 18 IND	HCM	138
	340/80 R 18 IND	TI-20	144
20"	360/80 R 20 IND	HCM	138
24"	360/80 R 24 IND	HCM	138
	400/80 R 24 IND	HCM	138
26"	440/80 R 24 IND	HCM	138
	480/80 R 26 IND	TI-20	144
28"	360/80 R 28 IND	HCM	138
	400/80 R 28 IND	HCM	138
30"	440/70 R 28 IND	AC 70 G	144
	440/80 R 28 IND	HCM	138
	440/80 R 30 IND	HCM	140
34"	540/65 R 30 IND	HCM	140
	440/80 R 34 IND	HCM	140
38"	480/80 R 34 IND	HCM	140
	480/80 R 38 IND	HCM	140
42"	540/80 R 38 IND	HCM	140
	650/65 R 42 IND	HCM	140
Multipurpose radial			
16"	265/70 R 16 MPT	AC 70 G	148
	285/80 R 16 MPT	AC 70 G	148
17"	425/55 R 17 MPT	AC 70 G	148
18"	325/70 R 18 MPT	AC 70 G	148
	365/70 R 18 MPT	AC 70 G	148
20"	275/80 R 20 MPT	AC 70 G	148
	335/80 R 20 MPT	AC 70 G	150
	365/80 R 20 MPT	MPT-21	150
	375/70 R 20 MPT	AC 70 G	150
	405/70 R 20 MPT	AC 70 G	150
	405/70 R 20 MPT	MPT-21	150
	425/75 R 20 MPT	AC 70 G	150
22.5"	445/65 R 22.5 MPT	AC 70 +	152
24"	405/70 R 24 MPT	AC 70 G	152
	445/70 R 24 MPT	AC 70 G	152
	495/70 R 24 MPT	AC 70 G	152
30"	495/70 R 30 MPT	AC 70 G	152

Size (inch)	Tire size (Alternative tire size)	Tread pattern	Page	
Agro-industrial diagonal				
18"	280/80-18 (10.5-18)	MPT-01	156	
	275/80-18 MPT (10.5-18)	TD-10	156	
	320/80-18	TD-10	162	
20"	340/80-18 (12.5-18)	MPT-01	156	
	275/80-20 MPT	TD-10	156	
	335/80-20 MPT	TD-10	156	
	340/80-20 (12.5-20)	MPT-01	156	
	360/80-20	TD-10	162	
24"	365/80-20 MPT	TD-10	156	
	400/70-20	TR-01	158	
	405/70-20 (16/70-20)	MPT-01	158	
	15.5/80-24	TR-01	158	
	15.5/80-24	TD-10	162	
	400/80-24 IND (15.5/80-24)	TI-05	160	
	405/70-24 (16/70-24)	MPT-01	158	
26"	16.5/85-24	TD-10	162	
	17.5L-24	TR-01	158	
	460/70-24 IND (17.5L-24)	TI-05	160	
	460/70-24 IND (17.5L-24)	TR-01	160	
	19.5L-24 IND	TI-05	160	
	500/70-24 IND (19.5L-24)	TI-05	160	
Tractor Agro-forestry				
24"	380/85-24 (14.9-24)	AF-01	166	
28"	380/85-28 (14.9-28)	AF-01	166	
30"	16.9-30	TL-01	166	
34"	420/85-34 (16.9-34)	AF-01	166	
	460/85-34 (18.4-34)	AF-01	166	
Tractor diagonal				
20"	8.3-20	TD-13	170	
24"	8.3-24	TD-02	170	
	9.5-24	TD-02	170	
	11.2-24	TD-02	170	
	11.2-24	TD-19	170	
	12.4-24	TD-02	170	
	12.4-24	TD-19	170	
	13.6-24	TD-19	170	
	14.9-24	TD-08	170	
	14.9-24	TD-19	170	
	16.9-24	TD-13	172	
	18.4-26	TD-19	172	
	23.1-26	TD-01	172	
	28"	11.2-28	TD-02	172
		12.4-28	TD-19	172
12.4-28		TD-02	172	
13.6-28		TD-19	172	
30"	14.9-28	TD-19	172	
	16.9-28	TD-13	172	
	16.9-30	TD-13	174	
	16.9-30	TD-17	174	
	18.4-30	TD-13	174	
	34"	16.9-34	TD-02	174
		16.9-34	TD-17	174
	36"	18.4-34	TD-19	174
		18.4-34	TD-02	174
	38"	12.4-36	TD-13	174
13.6-36		TD-13	176	
11.2-38		TD-13	176	
12.4-38		TD-17	176	
13.6-38		TD-13	176	
14.9-38		TD-05	176	
15.5-38		TD-05	176	
16.9-38		TD-19	176	
16.9-38		TD-13	176	
18.4-38		TD-19	176	

Size (inch)	Tire size (Alternative tire size)	Tread pattern	Page
Implement diagonal			
6"	13×5.00-6	G 1	180
	13×5.00-6	B 19	180
	15×6.00-6	B 19	180
8"	16×6.50-8	B 19	180
	18×8.50-8	G 1	180
	18.5×8.50-8	B 63	180
12"	10.0/80-12	IM-04	180
14.5"	200/60-14.5	IM-10	180
15"	240/70-15	B3	180
	28×9.00-15	AC30	180
	31×15.50-15	TR-06	190
15.3"	31×15.50-15	TR-07	190
	10.0/75-15.3	IM-04	182
	10.0/75-15.3	TR-03	190
16"	10.0/75-15.3	TR-04	190
	11.5/80-15.3	IM-04	182
	11.5/80-15.3	TR-03	190
15.5"	12.5/80-15.3	IM-04	182
	400/60-15.5	IM-07	182
	400/60-15.5	TR-08	190
16"	10.50-16	IM-01	182
17"	15.0/55-17	IM-04	184
	15.0/55-17	TR-01	192
	19.0/45-17	IM-04	184
17.5"	480/45-17	TR-01	192
	500/50-17	IM-07	184
	14-17.5	TR-10	192
18"	12.0/75-18	TR-03	192
	12.0/75-18	TR-11	192
	12.5/80-18	IM-03	184
20"	12.5/80-18	IM-04	184
	13.0/65-18	IM-04	186
	360/95-18	IM-02	186
22.5"	14.5/80-18	IM-03	186
	14.5/80-18	TR-05	192
	500/45-20	TR-12	192
20"	500/60-22.5	TR-08	194
	500/60-22.5	IM-09	186
	500/60-22.5	TR-12	194
22.5"	550/60-22.5	IM-09	186
	550/60-22.5	TR-08	194
	600/40-22.5	TR-12	194
600/50-22.5	TR-08	194	

Size (inch)	Tire size (Alternative tire size)	Tread pattern	Page
Tractor small			
6"	3.50-6	B 16	198
	13×5.00-6	B 12	198
8"	3.50-8	B 16	198
	4.00-8	B 12	198
	16×6.50-8	B 64	198
10"	4.00-10	B 12	198
	5.00-10	B 16	198
	5.0-10	B 17	198
12"	4.00-12	B 12	198
	5.00-12	TS-02	198
	5.00-12	B 12	198
14"	6.5/90-12 (170/90-12)	TS-06	198
	6.5/80-12	B 18	198
	11.0/65-12	TD-10	200
15"	6.5/75-14	TS-02	200
	5.00-15	TS-06	200
	6.5/90-15 (170/90-15)	TS-06	200
15.3"	690×180-15	TS-07	200
	10.0/75-15.3	TS-05	200
	11.5/80-15.3	TS-05	200
16"	6.00-16	TS-04	202
	6.00-16	TD-13	202
	6.50-16	TD-10	202
20"	7.50-16	TS-04	202
	7.50-16	TD-13	202
	7.50-20	TS-04	202
20"	7.50-20	TD-13	202
	8.3-20	TD-13	202
	Tractor front		
16"	6.00-16	TF-03	206
	6.50-16	TF-03	206
	7.50-16	TF-01	206
	7.50-16	TF-02	206
	7.50-16	TF-03	206
	9.00-16	TF-03	206
	10.00-16	TF-03	208
	11L-16	IM-05	208
	6.00-18	TF-03	208
	6.00-18	TF-04	208
20"	6.50-20	TF-03	208
	7.50-20	TF-01	208
	7.50-20	TF-03	208
Bantam			
6"	3.50-6	B 15	211
	3.50-6	B 15 Ribbed	211
	4.00-6	V-5501	211
8"	4.00-6	B 11	211
	3.50-8	V-5501	211
	3.50-8	B 11	211
	3.50-8	B 15	211
	4.00-8	V-5501B	211
	4.00-8	V-5501A	211
	4.00-8	B 11	211

Tire size marking

340/85 R 24	
340	Nominal section width (in mm)
85	Aspect ratio H/SW (in %)
R	Radial construction
24	Nominal rim diameter (in inches)

15.0/55 – 17	
15.0	Nominal section width (in inches)
55	Aspect ratio H/SW (in %)
–	Cross-ply construction
17	Nominal rim diameter (in inches)

31 × 15.50 – 15	
31	Overall diameter (in inches)
15.50	Nominal section width (in inches)
–	Cross-ply construction
15	Nominal rim diameter (in inches)

17.5 L – 24	
17.5	Nominal section width (in inches)
L	Reduced aspect ratio
–	Cross-ply construction
24	Nominal rim diameter (in inches)

7.50 – 20	
7.50	Nominal section width (in inches)
–	Cross-ply construction
20	Nominal rim diameter (in inches)

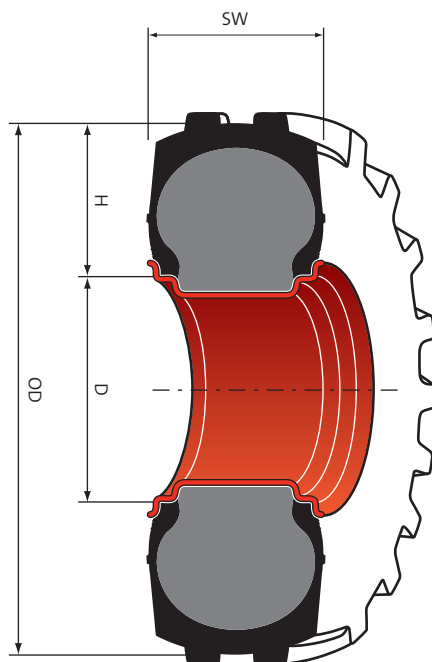

SW Section width
 OD Overall diameter
 H Section height
 D Rim diameter

Speed symbols and conversion tables

Speed category

Speed symbol	A1	A2	A3	A4	A5	A6	A7	A8	B	D	F	G	J	K
Speed (km/h)	5	10	15	20	25	30	35	40	50	65	80	90	100	110

Pressure units conversion table

bar	1.0	1.5	2.0	2.5	3.0	3.5	4.0	4.5	5.0	5.5
kPa	100	150	200	250	300	350	400	450	500	550
p. s. i.	15	22	29	36	44	51	58	65	73	80

bar	6.0	6.5	7.0	7.5	8.0	8.5	9.0	9.5	10.0	10.5
kPa	600	650	700	750	800	850	900	950	1 000	1 050
p. s. i.	87	94	102	109	116	123	131	138	145	152

Units conversion table

Length	Mass	Pressure
1 millimeter (mm) = 0.03937"	1 pound (lb) = 0.4536 kg	1 p. s. i. (lb/in ²) = 6.895 kPa
1 inch (") = 25.4 mm = 0.0254 m	1 kilogram (kg) = 2.205 lb	1 kg/cm ² = 98.066 kPa
1 meter (m) = 3.281 ft		1 bar = 100 kPa
1 foot (ft) = 0.3048 m		
1 kilometer (km) = 0.6214 mile	Volume	
1 mile = 1 609 m = 1.609 km	1 litre (l) = 0.21 gall	
	1 imperial gallon (imp.gal) = 4.55 l	

Tire sidewall marking



Sign	Meaning
MITAS	Tire brand
480/70 R 34	Tire size marking
HC 70	Tread pattern code
146	Load index (LI 146 = 3 000 kg)
A8	Speed symbol (A8 = 40 km/h)
143	Load index (LI 143 = 2 725 kg)
D	Speed symbol (D = 65 km/h)
TUBELESS	Tubeless tire
	Direction of rotation
R-1W	US tread profile marking

Tire structure

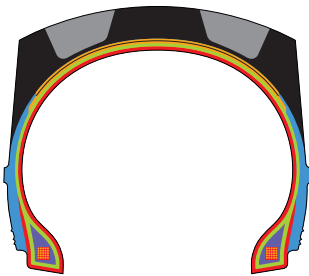

- Tread Pattern
- Breaker Cord
- Inner Liner
- Casing Cord
- Sidewall
- Apex
- Bead Wire



DIAGONAL (CROSS-PLY, BIAS) TIRE

A pneumatic tire in which the ply cords extend to the beads and are laid substantially at alternate angles less than 90° to the centre-line of the tread.



RADIAL PLY TIRE

A pneumatic tire in which the ply cords extend to the beads and are laid substantially at 90° to the centre-line of the tread, the carcass being stabilised by an essentially inextensible circumferential belt.

Load index

LI	kg	LI	kg	LI	kg	LI	kg	LI	kg
30	106	65	290	100	800	135	2 180	170	6 000
31	109	66	300	101	825	136	2 240	171	6 150
32	112	67	307	102	850	137	2 300	172	6 300
33	115	68	315	103	875	138	2 360	173	6 500
34	118	69	325	104	900	139	2 430	174	6 700
35	121	70	335	105	925	140	2 500	175	6 900
36	125	71	345	106	950	141	2 575	176	7 100
37	128	72	355	107	975	142	2 650	177	7 300
38	132	73	365	108	1 000	143	2 725	178	7 500
39	136	74	375	109	1 030	144	2 800	179	7 750
40	140	75	387	110	1 060	145	2 900	180	8 000
41	145	76	400	111	1 090	146	3 000	181	8 250
42	150	77	412	112	1 120	147	3 075	182	8 500
43	155	78	425	113	1 150	148	3 150	183	8 750
44	160	79	437	114	1 180	149	3 250	184	9 000
45	165	80	450	115	1 215	150	3 350	185	9 250
46	170	81	462	116	1 250	151	3 450	186	9 500
47	175	82	475	117	1 285	152	3 550	187	9 750
48	180	83	487	118	1 320	153	3 650	188	10 000
49	185	84	500	119	1 360	154	3 750	189	10 300
50	190	85	515	120	1 400	155	3 875	190	10 600
51	195	86	530	121	1 450	156	4 000	191	10 900
52	200	87	545	122	1 500	157	4 125	192	11 200
53	206	88	560	123	1 550	158	4 250	193	11 500
54	212	89	580	124	1 600	159	4 375	194	11 800
55	218	90	600	125	1 650	160	4 500	195	12 150
56	224	91	615	126	1 700	161	4 625	196	12 500
57	230	92	630	127	1 750	162	4 750	197	12 850
58	236	93	650	128	1 800	163	4 875	198	13 200
59	243	94	670	129	1 850	164	5 000	199	13 600
60	250	95	690	130	1 900	165	5 150	200	14 000
61	257	96	710	131	1 950	166	5 300		
62	265	97	730	132	2 000	167	5 450		
63	272	98	750	133	2 060	168	5 600		
64	280	99	775	134	2 120	169	5 800		

Main applications – Radial tires

We offer a wide range of tires for almost every piece of equipment and application – from high-horsepower tractors to massive harvesters, from field preparation to harvest.

Our extensive line of radial agricultural tires offers solutions to all your needs, from our **HC (High Capacity)** and **SFT (Super Flexion Tire)** series or our wide footprint **HC 70** and **AC 65** series tires to our **AC 85** and **AC 90** series for row-crop applications.

The development of the **SST (Silent Speed Tire)**, connects the outstanding field characteristics of a 65 series wide tire with high comfort. Because with the SST the noise level in the operator's cab is reduced to a minimum. The **HC (High Capacity)** and **SFT (Super Flexion Tire)** were developed primarily for powerful machines with over 180 hp. The extremely large volume of air ensures gentle ground handling when working with heavy loads. The new harvester tires **HC 3000** and **SFT CHO** have been designed as an extremely powerful



	HC 2000	HC 1000	SFT	SST	AC 65	
Product on page	18	24	28	40	44	
Type of tire	VF (Very High Flexion)	VF (Very High Flexion)	Super Flexion	Wide 65 series	Wide 65 series	
Tractor (hp)	> 180	–	> 180	< 220	< 220	
Max speed	65 km/h	65 km/h	65 km/h	65 km/h	65 km/h	
Road performance, Transports	++++	+++	+++++	+++++	++++	
Field work	+++++		+++++	++++	++++	
→ Cultivating, tillage (high torque)	+++++		+++++	++++	++++	
→ Seedbed preparation (high load)	+++++		+++++	++++	++++	
Grassland application	+++++		+++++	++++	++++	
Row Crop applications		+++++		+	+	
Harvester						
Vineyard & fruit growing		++++		+	++	

tires for big combine harvesters. **HC 3000** and **SFT CHO** are capable of higher maximum loads; at the same time the tire permits gentler ground handling in the field and more comfort on the road. For tractors with up to 200 hp, the Mitas range of radial tires offers wide choice of all-rounders. The 85 series standard radial **AC 85** is ideally suited for wide-ranging applications in the field and on the road. The **HC 70** the new 70 series wide tire, has higher load capacities than normally available in the 70 series segment; it therefore offers gentler

ground handling and can carry very heavy loads. The **AC 65** is a wide tire with a 65% aspect ratio and is the ideal choice in this tractor segment, where it's about gentle ground handling and the ability to transport heavy loads, as well as traction and grassland suitability. The **AC 70 G** is the acknowledged grassland tire in Mitas range. The **AC 70 T** is particularly suited for heavy field work. In the smaller sizes it has proved itself in vine cultivation and fruit growing.



	HC 70	AC 70 T	AC 70 G	AC 85	AC 85 / 90 Row Crop	HC 3000	CHO	SFT Harvester AC 70 H/G/N
	52	58	66	70	80	90	94	100
	Wide 70 series	Wide 70 series	Wide 70 series	Standard 85 series	Row Crop	Harvester (Cyclic Field Operation)	Harvester (Cyclic Harvesting Application)	Harvester
	< 200	< 200	< 200	< 220	–	–	–	–
	65 km/h	50 km/h	90 km/h	50 km/h	50 km/h	50 km/h	50 km/h	50 km/h
	+++	++	++++	+++	++	+++	+++	+++
	+++	+++	+++	+++				
	++++	+++	++++	+++				
	+++	++	+++	+++				
	++++	++	+++	+++		++++	++++	++++
	++	++	++	++++	++++			
						++++	++++	++++
	+++	++++	+++	+++	++++			

+++++ excellent

++++ very good

+++ good

++ suitable

+ somewhat suitable

kW	22	44	66	88	110	132	162	191	>220
hp	30	60	90	120	150	180	220	260	>300



HC 2000	
LOAD CAPACITY	● ● ● ● ● ● ● ●
TRACTION	● ● ● ● ● ● ● ●
SOIL PROTECTION	● ● ● ● ● ● ● ●
HANDLING ON ROAD	● ● ● ● ● ● ● ●

HC 2000 – VF tire

Very High Flexion

For high-horsepower tractors



Lower inflation pressure provides **excellent traction efficiency**.



Better ground protection thanks to reduced soil compaction.



Higher load capacity for higher haulage efficiency.



Constant tire pressure at any speed (VF concept).



HC 2000

Technical data and load capacities

Tire size	Service description LI/SS	Rims * (permitted)	Section width (mm)	Overall diameter (mm)	Loaded static radius (mm)	Rolling circumference (mm)	Speed radius index	
VF 420/85 R 28	151 D	DW 15 L DW 14 L	432 422	1 429	635	4 160	675	
VF 540/65 R 30	155 D	DW 20 B DW 18 L W 18 L	570 550 550	1 455	650	4 340	700	
VF 540/65 R 30	161 D (158 E)	DW 20 B DW 18 L W 18 L	574 554 554	1 461	660	4 410	700	
VF 600/70 R 30	165 D	DW 21 B DW 20 B	625 615	1 580	675	4 620	750	
VF 380/85 R 34	149 D	DW 13 L DW 12 L	396 386	1 500	678	4 500	725	
VF 420/85 R 34	154 D	DW 14 L DW 15 L	441 431	1 570	705	4 700	750	
VF 540/65 R 34	163 D	DW 20 B DW 18 L W 18 L	570 550 550	1 586	711	4 675	750	
VF 380/95 R 38	154 B	DW 13 DW 12	394 384	1 670	735	4 950	800	
VF 480/70 R 38	172 D	DW 16 L DW 15 L DW 18 L	486 476 506	1 641	760	5 090	800	
VF 520/85 R 42	174 B	DW 18 L DW 16 L	546 526	1 966	890	5 870	925	



HC 2000

Tractor radial tires

		Tire load capacity (kg) at tire pressure (bar)											Speed (km/h)	
		0.4	0.6	0.8	1.0	1.2	1.4	1.6	2.0	2.4	2.8	3.2		4.0
	1380	1 920 2 070 1 655	2 195 2 240 2 415 1 930	2 510 2 560 2 760 2 210	2 820 2 875 3 100 2 480	3 135 3 200 3 450 2 760	3 450 3 520 3 795 3 035							40-65 30 10 40-65 Dual
	1 680	2 000	2 680 2 890 2 310	2 900 2 960 3 190 2 550	3 310 3 375 3 640 2 915	3 610 3 680 3 970 3 175	3 875 3 955 4 265 3 410							40-65 30 10 40-65 Dual
	1 680	2 000	2 680 2 890 2 310	2 650 2 900 2 960 3 190 2 550	3 000 3 250 3 315 3 575 2 860	3 295 3 620 3 690 3 980 3 185	3 550 4 250 3 875 3 955 4 265 3 410	3 875 4 250 4 335 4 675 3 740	4 250 4 625 4 720 5 090 4 070					70 40-65 30 10 40-65 Dual
	2 080	2 495	3 370 3 635 2 910	3 780 3 855 4 160 3 325	4 250 4 335 4 675 3 740	4 725 4 820 5 200 4 160	5 150 5 255 5 665 4 530							40-65 30 10 40-65 Dual
	1 290	1 795 1 940 1 550	2 060 2 100 2 265 1 815	2 350 2 395 2 585 2 070	2 645 2 700 2 910 2 330	2 935 2 995 3 230 2 585	3 250 3 315 3 575 2 860							40-65 30 10 40-65 Dual
	1 505	2 100 2 265 1 810	2 395 2 445 2 635 2 110	2 740 2 795 3 015 2 410	3 080 3 140 3 390 2 710	3 425 3 495 3 770 3 015	3 750 3 825 4 125 3 300							40-65 30 10 40-65 Dual
		2 080	2 800 3 075 2 780 3 000 2 400	3 150 3 450 3 135 3 385 2 705	3 450 3 805 3 520 3 795 3 035	3 750 4 125 3 880 4 185 3 345	3 750 4 125 4 210 4 540 3 630	4 125 4 500 4 590 4 950 3 960	4 500 4 875 4 975 5 365 4 290					70 40-65 30 10 40-65 Dual
	1 500	2 085 2 250 1 800	2 450 2 500 2 695 2 155	2 725 2 780 3 000 2 400	3 050 3 110 3 355 2 685	3 375 3 445 3 715 2 970	3 750 3 825 4 125 3 300							40-50 30 10 40-50 Dual
	1 170	1 460	2 195 2 365 1 890	3 000 3 060 3 300 2 640	3 350 3 415 3 685 2 950	3 750 3 825 4 125 3 300	4 125 4 210 4 540 3 630	4 500 4 590 4 950 3 960	4 750 4 845 5 225 4 180	5 150 5 255 5 665 4 530	5 600 5 710 6 160 4 930	6 300 6 425 6 930 5 545	40-65 30 10 40-65 Dual	
	2 300	2 760	3 725 4 015 3 210	4 125 4 210 4 540 3 630	4 625 4 720 5 090 4 070	5 210 5 315 5 735 4 585	5 800 5 915 6 380 5 105	6 300 6 425 6 930 5 545	6 700 6 835 7 370 5 895					40-50 30 10 40-50 Dual

HC 2000

Technical data and load capacities

Tire size	Service description LI/SS	Rims * (permitted)	Section width (mm)	Overall diameter (mm)	Loaded static radius (mm)	Rolling circumference (mm)	Speed radius index	
VF 650/65 R 42	170 D	DW 23 B DW 21 B	671 651	1 910	860	5 740	925	
VF 710/70 R 42	179 D	DW 23 B DW 25 B	710 730	2 050	905	6 080	975	
VF 480/80 R 46	164 D	DW 16 L DW 15 L DW 18 L	480 470 500	1 940	870	5 800	925	
VF 480/80 R 46	175 D	DW 16 L DW 15 L DW 18 L	496 486 516	1 941	870	5 800	925	
VF 480/95 R 50	170 B	DW 16 L DW 15 L DW 18 L	485 475 505	2 150	970	6 400	1 050	
VF 380/105 R 54	168 B	W 13 W 12	398 388	2 145	970	6 420	1 050	

* Additional permitted rims may be available on request

Load values for 0.4 bar and 0.6 bar are for calculating Dual and triple load values only.

For plowing with single driven tires in the furrow, a minimum inflation pressure of 0.8 bar is required.

For intensive road transport at 65/50/40/30 km/h the pressure must be increased by 0.4 bar. Maximum inflation pressure should never be exceeded.

All load values are valid for ground slopes up to and including 20% (11°). When operating on slopes greater than 20%, please, contact the producer.

Tubeless tires – may be used with a tube.



HC 2000

Tractor radial tires

		Tire load capacity (kg) at tire pressure (bar)											Speed (km/h)		
		0.4	0.6	0.8	1.0	1.2	1.4	1.6	2.0	2.4	2.8	3.2		4.0	
				4 050	4 585	5 105	5 590	6 000							40–65 30 10
2 595	3 085			4 130	4 675	5 205	5 700	6 120							40–65 Dual
				4 455	5 045	5 615	6 150	6 600							
				3 565	4 035	4 495	4 920	5 280							
				5 030	5 600	6 240	6 950	7 750							40–65 30 10
3 075	3 690			5 130	5 710	6 365	7 090	7 905							40–65 Dual
				5 535	6 160	6 865	7 645	8 525							
				4 425	4 930	5 490	6 115	6 820							
				3 185	3 650	4 095	4 565	5 000							40–65 30 10
2 000	2 410			3 250	3 725	4 175	4 640	5 100							40–65 Dual
				3 505	4 015	4 505	5 005	5 500							
				2 805	3 210	3 605	4 005	4 400							
				3 250	3 725	4 175	4 655	5 100	5 450	5 800	6 500	6 900			40–65 30 10
2 000	2 410			3 505	4 015	4 505	5 020	5 500	5 560	5 915	6 630	7 040			40–65 Dual
				2 805	3 210	3 600	4 015	4 400	4 795	5 105	5 720	6 070			
				3 850	4 375	4 840	5 400	6 000							40–50 30 10
2 440	3 390			3 925	4 465	4 935	5 510	6 120							40–50 Dual
	3 655			4 235	4 815	5 325	5 940	6 600							
	2 925			3 390	3 850	4 260	4 750	5 280							
				3 150	3 575	4 000	4 375	4 750	5 300	5 600					40–50 30 10
2 030	2 790			3 215	3 645	4 080	4 460	4 845	5 405	5 710					40–50 Dual
	3 005			3 465	3 930	4 400	4 810	5 225	5 830	6 160					
	2 405			2 770	3 145	3 520	3 850	4 180	4 665	4 930					



HC 1000	
LOAD CAPACITY	● ● ● ● ● ● ● ●
TRACTION	● ● ● ● ● ● ● ●
SOIL PROTECTION	● ● ● ● ● ● ● ●
HANDLING ON ROAD	● ● ● ● ● ● ● ●



HC 1000 NRO	
LOAD CAPACITY	● ● ● ● ● ● ● ●
TRACTION	● ● ● ● ● ● ● ●
SOIL PROTECTION	● ● ● ● ● ● ● ●
HANDLING ON ROAD	● ● ● ● ● ● ● ●

HC 1000 – VF tire

Very High Flexion

For self-propelled sprayers



More lugs provide **better durability, longer service life and lower operation cost.**



Higher maximum speed (65 km/h) for less time on the road.



Reduced soil compaction for higher loads thanks to lower inflation pressure.



HC 1000

Technical data and load capacities

Tire size	Service description LI/SS	Rims * (permitted)	Section width (mm)	Overall diameter (mm)	Loaded static radius (mm)	Rolling circumference (mm)	Speed radius index	
VF 650/65 R 38 #	180 D	DW 23 B DW 21 B	655 635	1 825	805	5 400	875	
VF 380/90 R 46	173 D	DW 13 DW 12	399 389	1 846	835	5 540	900	
VF 750/60 R 46 #	189 D	DW 27 B DW 25 B DW 28 B	754 734 764	2 070	923	6 150	1 025	
VF 380/105 R 50	176 D	DW 13 DW 12	400 390	2 042	926	6 200	1 000	
VF 480/80 R 50	181 D	DW 16 L DW 15 L	503 493	2 064	910	6 100	975	
VF 320/105 R 54	169 D	DW 11 DW 10	335 325	2 044	920	6 150	1 000	

* Additional permitted rims may be available on request

NRO: The NRO marking allows VF tires to use narrower rims which are the same size as used with standard radial tires in the same dimension.

For intensive road transport at 65/50/40/30 km/h the pressure must be increased by 0.4 bar. Maximum inflation pressure should never be exceeded.

All load values are valid for ground slopes up to and including 20% (11°). When operating on slopes greater than 20%, please, contact the producer.

Tubeless tires – may be used with a tube.

HC 1000



HC 1000 NRO



Tractor radial tires

	Tire load capacity (kg) at tire pressure (bar)									Speed (km/h)
	1.0	1.6	2.0	2.4	2.8	3.2	3.6	4.0	4.4	
4 250	5 800	6 300	6 900	7 500	8 000					40-65
4 335	5 915	6 425	7 040	7 650	8 160					30
4 675	6 380	6 930	7 590	8 250	8 800					10
3 740	5 105	5 545	6 070	6 600	7 040					40-65 Dual
2 800	3 875	4 250	4 625	5 025	5 425	5 775	6 125	6 500		40-65
2 855	3 955	4 335	4 720	5 125	5 535	5 890	6 250	6 630		30
3 080	4 265	4 675	5 090	5 530	5 970	6 355	6 740	7 150		10
2 465	3 410	3 740	4 070	4 420	4 775	5 080	5 390	5 720		40-65 Dual
5 300	7 300	8 000	8 750	9 500	10 300					40-65
5 405	7 445	8 160	8 925	9 690	10 505					30
5 830	8 030	8 800	9 625	10 450	11 330					10
4 665	6 425	7 040	7 700	8 360	9 065					40-65 Dual
3 875	4 750	5 100	5 450	5 975	6 500	6 900	7 100			40-65
3 955	4 845	5 200	5 560	6 095	6 630	7 040	7 240			30
4 265	5 225	5 610	5 995	6 570	7 150	7 590	7 810			10
3 410	4 180	4 485	4 795	5 255	5 720	6 070	6 250			40-65 Dual
3 870	5 320	5 840	6 220	6 785	7 355	7 800	8 250			40-65
3 945	5 425	5 955	6 345	6 920	7 500	7 955	8 415			30
4 255	5 850	6 425	6 840	7 465	8 090	8 580	9 075			10
3 405	4 680	5 140	5 475	5 970	6 470	6 865	7 260			40-65 Dual
2 730	3 750	4 115	4 385	4 785	5 185	5 490	5 800			40-65
2 785	3 825	4 195	4 475	4 880	5 290	5 600	5 915			30
3 005	4 125	4 525	4 825	5 265	5 705	6 040	6 380			10
2 400	3 300	3 620	3 860	4 210	4 565	4 835	5 105			40-65 Dual

SFT – Super Flexion Tire

Maximum load capacity and traction for powerful machines



Developed for use on **high-horsepower tractors (> 180 hp) and combines.**



Flexible sidewalls allow low inflation pressures **for high load-carrying capacities**, gentle ground handling and higher yields.



Maximum traction and outstanding productivity thanks to transport speeds of 65 km/h and a large contact patch.



SFT

Technical data and load capacities

Tire size	Service description L/SS	Rims * (permitted)	Section width (mm)	Overall diameter (mm)	Loaded static radius (mm)	Rolling circumference (mm)	Speed radius index	
1000/50 R 25	178 A8 (172 D)	36.0 TH 36.0 VA	1 020	1 655	740	4 930	775	
620/75 R 26	166 A8 (166 B)	DW 20 B	625	1 590	689	4 660	750	
750/65 R 26	166 D (169 A8)	DW 23 B DW 25 B	738 758	1 620	720	4 800	775	
750/65 R 26	171 D (174 A8)	DW 23 B DW 25 B	750 770	1 615	720	4 800	775	
540/65 R 28	142 D (145 A8)	W 16 L W 18 L W 15 L	540 560 540	1 414	627	4 210	675	
600/65 R 28	154 D (157 A8)	W 18 L DW 20 B	606 626	1 494	664	4 444	700	
600/70 R 28	157 D (160 A8)	W 18 L DW 20 B	627 647	1 574	696	4 660	725	
600/70 R 28	161 D (164 A8)	W 18 L DW 20 B	630 650	1 578	698	4 670	725	
540/65 R 30	150 D (153 A8)	W 16 L W 18 L W 15 L	548 558 540	1 487	668	4 435	700	

SFT



Tire load capacity (kg) at tire pressure (bar)												Speed (km/h)
0.4	0.6	0.8	1.0	1.2	1.4	1.6	2.0	2.4	2.8	3.2		
			3 470	3 905	4 355	4 790	5 355	5 735	6 300			65
			3 430	3 855	4 340	4 835	5 320	5 950	6 370	7 000		50
			3 830	4 250	4 780	5 270	5 800	6 445	6 900	7 500		40
			4 025	4 460	5 020	5 540	6 095	6 765	7 245	7 935		30
			4 550	5 045	5 675	6 265	6 890	7 650	8 190	8 970		10
			2 480	2 835	3 190	3 545	3 875	4 280	4 500	4 995	5 300	50
			2 655	3 035	3 415	3 795	4 145	4 580	4 815	5 345	5 300	40
			2 755	3 150	3 540	3 935	4 300	4 750	4 995	5 540	5 670	30
			3 050	3 490	3 925	4 360	4 765	5 265	5 535	6 140	5 885	25
			3 225	4 535	4 150	5 670	5 040	5 565	5 850	6 490	6 520	20
				3 605	3 895	4 155	4 375	4 875	5 300			10
			3 445	3 785	4 090	4 360	4 595	5 120	5 565			65
		3 200	3 595	3 950	4 265	4 545	4 750	5 340	5 800			50
		3 360	3 775	4 150	4 480	4 775	5 030	5 605	6 095			40
	3 535	4 090	4 595	5 050	5 455	5 815	6 125	6 825	7 420	7 950		30
				3 895	4 070	4 250	4 875	5 300	5 800			10
			3 445	3 765	4 090	4 275	4 465	5 120	5 565	6 090	6 150	65
			3 595	3 930	4 265	4 460	4 655	5 340	5 800	6 300	6 460	50
			3 770	4 125	4 480	4 685	4 890	5 605	6 095	6 670	6 700	40
			4 590	5 020	5 455	5 700	5 950	6 825	7 420	8 120	7 070	30
				2 210	2 385	2 530	2 650				8 610	10
				2 320	2 505	2 655	2 785					65
		1 960	2 200	2 420	2 615	2 770	2 900					50
		2 060	2 315	2 540	2 745	2 910	3 050					40
	2 165	2 505	2 815	3 095	3 340	3 545	3 710	3 975				30
				2 605	2 815	2 995	3 150	3 490	3 750			10
			2 490	2 735	2 955	3 145	3 310	3 665	3 940			65
			2 595	2 855	3 080	3 280	3 450	3 820	4 125			50
			2 425	2 725	2 995	3 235	3 445	3 625	4 010	4 315		40
		2 555	2 955	3 320	3 650	3 940	4 195	4 410	4 885	5 250	5 625	30
				2 900	3 175	3 380	3 550	3 900	4 125			10
			2 730	3 045	3 335	3 550	3 730	4 095	4 330			65
			2 505	2 850	3 175	3 480	3 700	3 875	4 500			50
			2 630	2 990	3 335	3 655	3 885	4 085	4 485	4 745		40
	2 730	3 200	3 640	4 060	4 450	4 730	4 970	5 460	5 775	6 190		30
				2 900	3 175	3 380	3 550	3 900	4 125	4 625		10
			2 730	3 045	3 335	3 550	3 730	4 095	4 330	4 855		65
			2 505	2 850	3 175	3 480	3 700	3 875	4 270	4 500	5 000	50
			2 630	2 990	3 335	3 655	3 885	4 085	4 485	4 745	5 320	40
	2 730	3 200	3 640	4 060	4 450	4 730	4 970	5 460	5 775	6 475		30
				2 280	2 465	2 605	2 725	3 080	3 350			10
			2 180	2 395	2 585	2 735	2 860	3 235	3 520			65
			2 270	2 495	2 695	2 855	3 000	3 375	3 650			50
			2 125	2 385	2 620	2 830	3 000	3 135	3 545	3 855		40
	2 235	2 585	2 905	3 190	3 450	3 650	3 815	4 315	4 690	5 025		30
												10

SFT

Technical data and load capacities

Tire size	Service description L/SS	Rims * (permitted)	Section width (mm)	Overall diameter (mm)	Loaded static radius (mm)	Rolling circumference (mm)	Speed radius index	
600/70 R 30	152 D (155 A8)	W 18 L DW 20 B	625 645	1 595	700	4 700	750	
620/75 R 30	166 D (169 A8)	W 20 B W 18 L W 21 B	635 615 645	1 700	740	4 980	800	
710/55 R 30	159 D (162 A8)	DW 23 B	690	1 500	674	4 475	725	
710/60 R 30	162 D (165 A8)	DW 23 B	708	1 646	730	4 870	775	
750/55 R 30	162 D (165 A8)	DW 23 B	720	1 584	712	4 725	750	
800/70 R 32	175 A8 (172 B)	DW 25 B DW 27 B	762 784	1 932	845	5 630	900	
900/60 R 32	176 A8 (173 B)	DW 27 B DW 30 B	857 890	1 905	850	5 700	900	
900/60 R 32	181 A8 (178 B)	DW 27 B DW 30 B	857 890	1 910	850	5 700	900	
900/70 R 32	188 A8 (185 B)	DW 27 B DW 30 B	895 925	2 050	896	6 050	975	



SFT

Tractor radial tires

Tire load capacity (kg) at tire pressure (bar)												Speed (km/h)
0.4	0.6	0.8	1.0	1.2	1.4	1.6	2.0	2.4	2.8	3.2		
2 810			2 985	3 270	3 430	3 550						65
		2 575	2 815	3 135	3 435	3 605	3 730					50
		2 705	2 935	3 270	3 585	3 755	3 875					40
		2 705	3 080	3 435	3 765	3 945	4 085					30
		3 295	3 750	4 180	4 580	4 805	4 970	5 325				10
2 440			3 005	3 380	3 755	4 125	4 555	4 875	5 300			65
		2 465	2 760	3 155	3 550	3 940	4 330	4 780	5 120	5 565		50
		2 590	2 880	3 290	3 700	4 110	4 515	4 985	5 300	5 800		40
		2 930	3 025	3 455	3 885	4 315	4 745	5 235	5 605	6 205		30
		2 930	3 415	3 905	4 395	4 880	5 365	5 920	6 340	7 540	8 700	10
2 670			2 805	3 065	3 365	3 650	4 045	4 375				65
		2 440	2 655	2 945	3 220	3 530	3 835	4 250	4 595			50
		2 560	2 765	3 075	3 360	3 680	4 000	4 430	4 750			40
		3 115	2 905	3 230	3 525	3 865	4 200	4 655	5 030			30
		3 115	3 540	3 930	4 295	4 710	5 110	5 665	6 125	6 565		10
2 885			3 035	3 315	3 605	3 875	4 385	4 750				65
		2 635	2 870	3 185	3 480	3 785	4 070	4 605	4 990			50
		2 770	2 990	3 325	3 630	3 945	4 250	4 800	5 150			40
		3 370	3 140	3 490	3 815	4 145	4 455	5 040	5 465			30
		3 370	3 825	4 250	4 645	5 045	5 425	6 135	6 650	7 125		10
2 905			3 060	3 340	3 675	4 000	4 400	4 750				65
		2 655	2 890	3 210	3 510	3 860	4 200	4 620	4 990			50
		2 790	3 015	3 350	3 660	4 025	4 375	4 820	5 150			40
		3 395	3 165	3 515	3 845	4 225	4 600	5 060	5 465			30
		3 395	3 855	4 280	4 680	5 145	5 600	6 160	6 650	7 125		10
			4 180	4 575	5 010	5 450	5 965	6 300				50
		3 815	4 235	4 590	5 025	5 505	6 000	6 555	6 900			40
		4 085	4 530	4 915	5 380	5 895	6 420	7 015	7 385			30
		4 235	4 700	5 095	5 580	6 115	6 600	7 275	7 660			25
		4 695	5 210	5 650	6 180	6 775	7 380	8 060	8 485			20
			4 250	4 650	5 020	5 450	5 950	6 500				50
		3 890	4 315	4 670	5 110	5 515	6 000	6 535	7 100			40
		4 165	4 615	5 000	5 465	5 900	6 420	6 995	7 595			30
		4 320	4 790	5 185	5 670	6 120	6 660	7 255	7 880			25
		4 790	5 305	5 745	6 285	6 785	7 380	8 040	8 735			20
			4 250	4 650	5 020	5 450	5 950	6 500				50
		3 890	4 315	4 670	5 110	5 515	6 000	6 535	7 100	7 025	7 500	40
		4 165	4 615	5 000	5 465	5 900	6 420	6 995	7 595	8 260	8 830	30
		4 320	4 790	5 185	5 670	6 120	6 660	7 255	7 880	8 570	9 160	25
		4 790	5 305	5 745	6 285	6 785	7 380	8 040	8 735	9 495	10 150	20
			4 250	4 650	5 020	5 450	5 950	6 500				50
		3 890	4 315	4 670	5 110	5 515	6 000	6 535	7 100	7 025	7 500	40
		4 165	4 615	5 000	5 465	5 900	6 420	6 995	7 595	8 260	8 830	30
		4 320	4 790	5 185	5 670	6 120	6 660	7 255	7 880	8 570	9 160	25
		4 790	5 305	5 745	6 285	6 785	7 380	8 040	8 735	9 495	10 150	20
			5 055	5 530	6 060	6 700	7 215	7 750	8 415	9 250		50
		4 615	5 120	5 555	6 080	6 660	7 300	7 925	8 500	9 250	10 000	40
		4 940	5 480	5 945	6 505	7 125	7 810	8 480	9 095	9 895	10 700	30
		5 125	5 685	6 165	6 750	7 395	8 105	8 800	9 435	10 265	11 100	25
		5 675	6 300	6 830	7 475	8 195	8 980	9 750	10 455	11 375	12 300	20
	6 000	6 660	7 220	7 905	8 660	9 490	10 305	11 050	12 025	13 000	10	

SFT

Technical data and load capacities

Tire size	Service description L/SS	Rims * (permitted)	Section width (mm)	Overall diameter (mm)	Loaded static radius (mm)	Rolling circumference (mm)	Speed radius index	
1050/50 R 32	178 A8 (178 B)	36.00 VA	1 015	1 890	855	5 640	875	
1250/50 R 32	188 A8 (185 B)	44" 40"	1 220 1 180	2 020	890	6 000	975	
1250/50 R 32	194 A8 (191 B)	44" 40"	1 220 1 180	2 020	890	6 000	975	
650/60 R 34	159 D (162 A8)	DW 20 B DW 21 B DW 23 B	650 660 680	1 638	740	4 935	775	
650/65 R 34	161 D (164 A8)	DW 20 B DW 21 B DW 23 B	664 674 694	1 719	769	5 116	825	
710/60 R 34	164 D (167 A8)	DW 23 B	700	1 700	770	5 060	825	
650/65 R 38	157 D (160 A8)	W 18 L DW 20 B DW 21 B	645 660 670	1 828	810	5 445	875	
650/75 R 38	169 D (172 A8)	DW 21 B DW 20 B DW 23 B	667 657 687	1 944	872	5 795	925	
650/85 R 38	173 D (176 A8)	DW 23 B DW 20 B DW 21 B	720 688 699	2 070	920	6 130	975	



Tire load capacity (kg) at tire pressure (bar)												Speed (km/h)
0.4	0.6	0.8	1.0	1.2	1.4	1.6	2.0	2.4	2.8	3.2		
			5 045	5 515	5 955	6 500	7 055	7 500				50
	4 200	4 655	5 045	5 515	5 955	6 500	7 055	7 500				40
	4 495	4 985	5 395	5 900	6 370	6 955	7 550	8 025				30
	4 665	5 170	5 595	6 120	6 610	7 215	7 830	8 325				25
	5 170	5 730	6 200	6 785	7 320	7 995	8 680	9 225				20
	5 465	6 055	6 555	7 170	7 740	8 450	9 175	9 750	11 250			10
		5 020	5 655	6 265	6 960	7 750	8 500	9 250				50
	4 730	5 515	6 210	6 885	7 650	8 500	9 340	10 000				40
	5 060	5 905	6 645	7 265	8 185	9 095	9 995	10 700				30
	5 250	6 125	6 895	7 640	8 490	9 435	10 370	11 100				25
	5 815	6 785	7 640	8 470	9 410	10 455	11 490	12 300				20
	6 620	7 725	8 695	9 640	10 710	11 900	13 075	14 000				10
		5 020	5 655	6 265	6 960	7 750	8 500	9 250	10 040	10 900		50
	4 730	5 515	6 210	6 885	7 650	8 500	9 340	10 000	11 035	11 800		40
	5 060	5 905	6 645	7 265	8 185	9 095	9 995	10 700	11 805	12 625		30
	5 250	6 125	6 895	7 640	8 490	9 435	10 370	11 100	12 245	13 100		25
	5 815	6 785	7 640	8 470	9 410	10 455	11 490	12 300	13 570	14 515		20
	6 620	7 725	8 695	9 640	10 710	11 900	13 075	14 000	15 445	16 520		10
		2 795	3 055	3 355	3 650	4 040	4 375					65
		2 935	3 210	3 525	3 835	4 240	4 595					50
	2 430	2 755	3 060	3 345	3 675	4 000	4 420	4 750				40
	2 550	2 895	3 215	3 515	3 860	4 200	4 645	5 030				30
2 660	3 105	3 525	3 915	4 280	4 700	5 110	5 655	6 125	6 565			10
		3 070	3 215	3 475	3 690	3 875	4 305	4 625				65
		3 205	3 375	3 645	3 875	4 070	4 520	4 855				50
	2 850	3 205	3 520	3 800	4 040	4 250	4 710	5 000				40
	2 995	3 365	3 695	3 995	4 245	4 455	4 950	5 320				30
3 150	3 645	4 095	4 500	4 860	5 165	5 425	6 025	6 475	6 940			10
		3 030	3 365	3 680	4 010	4 300	4 855	5 250				65
		3 160	3 510	3 835	4 185	4 500	5 060	5 450				50
	2 785	3 320	3 685	4 030	4 395	4 745	5 315	5 750				40
3 050	3 560	4 040	4 490	4 905	5 350	5 775	6 470	7 000	7 500			10
		3 380	3 655	3 905	4 125							65
		3 550	3 835	4 100	4 330							50
	3 000	3 370	3 705	4 000	4 275	4 500						40
	3 150	3 540	3 890	4 200	4 490	4 745						30
3 315	3 835	4 310	4 735	5 115	5 465	5 775	6 190					10
		3 990	4 375	4 645	4 875	5 425						65
		4 190	4 590	4 880	5 120	5 695	6 090	5 800				50
	3 445	3 920	4 370	4 790	5 085	5 300	5 940	6 300				40
	3 620	4 120	4 590	5 030	5 340	5 605	6 235	6 670				30
3 760	4 405	5 015	5 585	6 125	6 505	6 825	7 590	8 120	8 700			10
		4 465	4 895	5 195	5 450	6 075	6 500					65
		4 690	5 140	5 455	5 725	6 375	6 825	7 100				50
	3 855	4 390	4 890	5 360	5 690	6 000	6 650	7 100				40
	4 050	4 610	5 135	5 630	5 975	6 270	6 985	7 475				30
4 210	4 930	5 610	6 250	6 855	7 275	7 630	8 500	9 100	9 750			10

SFT

Technical data and load capacities

Tire size	Service description L/SS	Rims * (permitted)	Section width (mm)	Overall diameter (mm)	Loaded static radius (mm)	Rolling circumference (mm)	Speed radius index	
710/70 R 38	166 D (169 A8)	DW 23 B DW 25 B	736 756	1 958	870	5 780	925	
710/70 R 38	171 D (174 A8)	DW 23 B DW 25 B	736 756	1 958	870	5 780	925	
800/70 R 38	173 D (176 A8)	DW 25 B DW 27 B	765 787	2 052	911	6 090	975	
800/70 R 38	178 D (181 A8)	DW 25 B DW 27 B	765 787	2 052	911	6 090	975	
900/60 R 38	172 D (175 A8)	DW 27 B DW 30 B	870 900	2 060	918	6 115	975	
900/60 R 38	178 D (181 A8)	DW 27 B DW 30 B	870 900	2 060	918	6 115	975	
580/85 R 42	163 D (166 A8)	W 18 L DW 20 B DW 21 B	567 587 597	2 045	920	6 100	975	
580/85 R 42	168 D (171 A8)	W 18 L DW 20 B DW 21 B	590 610 620	2 050	920	6 100	975	
650/75 R 42	165 D (168 A8)	DW 21 B DW 20 B DW 23 B	650 640 670	2 035	905	6 090	975	



Tire load capacity (kg) at tire pressure (bar)												Speed (km/h)
0.4	0.6	0.8	1.0	1.2	1.4	1.6	2.0	2.4	2.8	3.2		
4 055	3 715 3 905 4 750	4 055 4 230 4 445 5 410	4 305	4 720	5 030	5 300	7 950	9 950	11 250	11 250	65	
			4 520	4 955	5 280	5 565					50	
			4 715	5 170	5 510	5 800					40	
			4 950	5 425	5 785	6 095					30	
4 055	3 715 3 905 4 750	4 055 4 230 4 445 5 410	4 305	4 720	5 030	5 300	5 805	6 150	9 225	9 225	9 225	65
			4 520	4 955	5 280	5 565	6 095	6 460				50
			4 715	5 170	5 510	5 800	6 355	6 700				40
			4 950	5 425	5 785	6 095	6 675	7 075				30
4 890	4 480 4 705 5 730	4 890 5 100 5 360 6 525	5 190	5 690	6 070	6 500	9 850	9 850	11 250	11 250	11 250	65
			5 450	5 975	6 375	6 720						50
			5 685	6 230	6 650	7 100						40
			5 970	6 545	6 980	7 360						30
4 890	4 480 4 705 5 730	4 890 5 100 5 360 6 525	5 190	5 690	6 070	6 400	7 035	7 500	10 500	11 250	11 250	65
			5 450	5 975	6 375	6 720	7 390	7 875				50
			5 685	6 230	6 650	7 010	7 705	8 250				40
			5 970	6 545	6 980	7 360	8 090	8 625				30
4 635	4 235 4 450 5 415	4 610 4 805 5 050 6 145	4 875	5 325	5 825	6 300	9 450	9 450	11 250	11 250	11 250	65
			5 120	5 595	6 115	6 615						50
			5 340	5 835	6 375	6 900						40
			5 605	6 125	6 695	7 245						30
4 635	4 235 4 450 5 415	4 610 4 805 5 050 6 145	4 875	5 325	5 825	6 300	6 985	7 500	10 500	11 250	11 250	65
			5 120	5 595	6 115	6 615	7 335	7 875				50
			5 340	5 835	6 375	6 900	7 650	8 250				40
			5 605	6 125	6 695	7 245	8 035	8 625				30
3 420	3 125 3 285 3 995	3 405 3 550 3 730 4 540	3 605	3 945	4 405	4 875	7 260	7 260	11 250	11 250	11 250	65
			4 140	4 630	5 120	5 605						50
			4 320	4 825	5 300	5 785						40
			4 535	5 070	5 605	6 095						30
3 420	3 125 3 285 3 995	3 405 3 550 3 730 4 540	3 605	3 945	4 405	4 875	5 275	5 600	7 840	7 840	7 840	65
			4 140	4 630	5 120	5 540	5 880	6 150				50
			4 320	4 825	5 300	5 775	6 065	6 440				40
			4 535	5 070	5 605	6 065	6 440	6 825				30
3 935	3 605 3 785 4 605	3 935 4 100 4 305 5 245	4 175	4 575	4 885	5 150	7 725	7 725	11 250	11 250	11 250	65
			4 380	4 805	5 125	5 410						50
			4 570	5 010	5 345	5 600						40
			4 800	5 260	5 615	5 925						30
3 935	3 605 3 785 4 605	3 935 4 100 4 305 5 245	4 175	4 575	4 885	5 150	7 725	7 725	11 250	11 250	11 250	65
			4 380	4 805	5 125	5 410						50
			4 570	5 010	5 345	5 600						40
			4 800	5 260	5 615	5 925						30
3 935	3 605 3 785 4 605	3 935 4 100 4 305 5 245	4 175	4 575	4 885	5 150	7 725	7 725	11 250	11 250	11 250	65
			4 380	4 805	5 125	5 410						50
			4 570	5 010	5 345	5 600						40
			4 800	5 260	5 615	5 925						30
3 935	3 605 3 785 4 605	3 935 4 100 4 305 5 245	4 175	4 575	4 885	5 150	7 725	7 725	11 250	11 250	11 250	65
			4 380	4 805	5 125	5 410						50
			4 570	5 010	5 345	5 600						40
			4 800	5 260	5 615	5 925						30
3 935	3 605 3 785 4 605	3 935 4 100 4 305 5 245	4 175	4 575	4 885	5 150	7 725	7 725	11 250	11 250	11 250	65
			4 380	4 805	5 125	5 410						50
			4 570	5 010	5 345	5 600						40
			4 800	5 260	5 615	5 925						30
3 935	3 605 3 785 4 605	3 935 4 100 4 305 5 245	4 175	4 575	4 885	5 150	7 725	7 725	11 250	11 250	11 250	65
			4 380	4 805	5 125	5 410						50
			4 570	5 010	5 345	5 600						40
			4 800	5 260	5 615	5 925						30
3 935	3 605 3 785 4 605	3 935 4 100 4 305 5 245	4 175	4 575	4 885	5 150	7 725	7 725	11 250	11 250	11 250	65
			4 380	4 805	5 125	5 410						50
			4 570	5 010	5 345	5 600						40
			4 800	5 260	5 615	5 925						30
3 935	3 605 3 785 4 605	3 935 4 100 4 305 5 245	4 175	4 575	4 885	5 150	7 725	7 725	11 250	11 250	11 250	65
			4 380	4 805	5 125	5 410						50
			4 570	5 010	5 345	5 600						40
			4 800	5 260	5 615	5 925						30
3 935	3 605 3 785 4 605	3 935 4 100 4 305 5 245	4 175	4 575	4 885	5 150	7 725	7 725	11 250	11 250	11 250	65
			4 380	4 805	5 125	5 410						50
			4 570	5 010	5 345	5 600						40
			4 800	5 260	5 615	5 925						30

SFT

Technical data and load capacities

Tire size	Service description L/SS	Rims * (permitted)	Section width (mm)	Overall diameter (mm)	Loaded static radius (mm)	Rolling circumference (mm)	Speed radius index
680/80 R 42	180 D (183 A8)	DW 21 B DW 20 B DW 23 B	660 650 680	2 160	965	6 400	1 025
710/70 R 42	173 D (176 A8)	DW 23 B DW 25 B	731 751	2 070	935	6 150	975
710/75 R 42	175 D (178 A8)	DW 23 B DW 25 B	751 771	2 171	971	6 460	1 000
900/60 R 42	180 D (183 A8)	DW 27 B DW 30 B	860 890	2 150	970	6 440	1 025
710/65 R 46	174 D (177 A8)	DW 23 B DW 25 B	700 720	2 090	945	6 220	1 000
IF 710/65 R 46	183 D	DW 25 B DW 27 B	716 736	2 090	945	6 220	1 000

* Additional permitted rims may be available on request

Load values for 0.4 bar and 0.6 bar are for calculating dual and triple load values only. 30 km/h (up to 40 km/h) load values also apply for low-speed high-torque field work.

For plowing with single driven tires in the furrow, a minimum inflation pressure of 0.8 bar is required.

For intensive road transport at 65/50/40/30 km/h the pressure must be increased by 0.4 bar. Maximum inflation pressure should never be exceeded.

All load values are valid for ground slopes up to and including 20% (11°). When operating on slopes greater than 20%, please, contact the producer.

Tubeless tires – may be used with a tube.

SFT



	Tire load capacity (kg) at tire pressure (bar)											Speed (km/h)
	0.4	0.6	0.8	1.0	1.2	1.4	1.6	2.0	2.4	2.8	3.2	
			4 350	4 495	4 920	5 390	5 800	6 415	6 900	7 490	8 000	65
		4 090	4 540	4 920	5 385	5 900	6 350	7 025	7 555	8 200	8 750	50
		4 295	4 765	5 170	5 660	6 200	6 670	7 600	7 935	8 615	9 200	40
4 150	4 855	5 390	5 845	6 400	7 010	7 540	8 345	8 970	9 735	10 400		30
			4 245	4 500	4 935	5 285	5 600	6 100	6 500			65
		3 885	4 425	4 725	5 180	5 550	5 880	6 405	6 825			50
		4 080	4 645	4 930	5 405	5 790	6 150	6 680	7 100			40
4 240	4 970	5 655	6 305	6 910	7 400	7 840	8 540	9 100	9 750			30
			4 785	5 245	5 640	6 000	6 480	6 900				65
		4 130	4 510	5 025	5 510	5 925	6 300	6 805	7 245			50
		4 340	4 700	5 240	5 745	6 175	6 500	7 095	7 500			40
4 510	5 280	6 010	6 700	7 345	7 900	8 400	9 070	9 660	10 350			30
			5 095	5 565	6 135	6 700	7 370	8 000				65
		4 425	5 020	5 845	6 445	7 035	7 735	8 400	9 100			50
		4 645	5 270	5 855	6 400	7 055	7 705	8 350	9 000			40
4 840	5 655	6 420	7 130	7 790	8 590	9 380	10 315	11 200	12 000			30
			4 235	4 575	4 880	5 150	5 695	6 150	6 700			65
		3 755	4 045	4 445	4 805	5 125	5 410	5 980	6 460	7 035		50
		3 945	4 220	4 640	5 010	5 345	5 640	6 235	6 700	7 300		40
4 150	4 800	5 395	5 930	6 405	6 835	7 210	7 970	8 610	9 380	7 705		30
			4 625	5 150	5 675	6 150	6 800	7 300	8 000	8 750		40-65
	3 690	4 290	4 810	5 355	5 875	6 395	7 070	7 590	8 320	9 100		30
3 450	4 080	4 745	5 320	5 920	6 495	7 070	7 820	8 395	9 200	10 065		10
2 640	3 120	3 630	4 070	4 530	4 995	5 410	5 985	6 425	7 040	7 700		40-65 Dual

Tractor radial tires | SST

kW	22	44	66	88	110	132	150	162	184	>220
hp	30	60	90	120	150	180	200	220	250	>300





SST

LOAD CAPACITY	● ● ● ● ●
TRACTION	● ● ● ● ● ●
SOIL PROTECTION	● ● ● ● ●
HANDLING ON ROAD	● ● ● ● ● ●

SST – Silent Speed Tire

Fast, powerful and impressively quiet

- 

Noise reduction of up to 6 dB(A) in the cab maximises concentration and minimises stress.
- 

New casing construction ensures a **cost saving through reduced rolling resistance, long tire life and high damage resistance.**
- 

Highest levels of productivity achieved through the excellent characteristics of the low profile and casing.
- 

Highest possible sustained speed capability of up to 70 km/h.

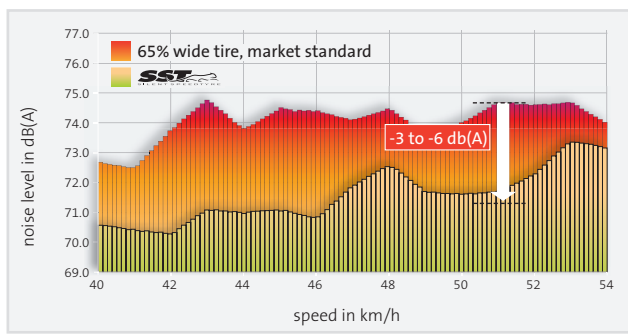

The SST (Silent Speed Tire) traction tire prevents the occurrence of the so-called “booming noise effect”. The SST reduces the noise level in the driver’s cab by 3 to 6 dB(A) compared with conventional rear axle tires.



SST

Technical data and load capacities

Tire size	Service description L/SS	Rims * (permitted)	Section width (mm)	Overall diameter (mm)	Loaded static radius (mm)	Rolling circumference (mm)	Speed radius index
600/65 R 38	153 D (156 A8)	W 18 L DW 18 L W 16 L	591 591 571	1 746	782	5 215	825
650/65 R 38	157 D (160 A8)	W 18 L DW 20 B	623 643	1 822	810	5 420	875
710/70 R 38	171 D (168 E)	DW 23 A DW 25 A	740 750	1 954	870	5 780	925
650/65 R 42	165 D (168 A8)	W 18 L DW 20 B	616 636	1 930	870	5 790	925
710/70 R 42	173 D (170 E)	DW 23 A DW 25 A	735 755	2 056	935	6 150	975
710/75 R 42	175 D (172 E)	DW 23 A DW 25 A	740 760	2 160	970	6 460	1 000

* Additional permitted rims may be available on request

Load values for 0.4 bar and 0.6 bar are for calculating dual and triple load values only.
30 km/h (up to 40 km/h) load values also apply for low-speed high-torque field work.

For plowing with single driven tires in the furrow, a minimum inflation pressure of 0.8 bar is required.

For intensive road transport at 65/50/40/30 km/h the pressure must be increased by 0.4 bar. Maximum inflation pressure should never be exceeded.

All load values are valid for ground slopes up to and including 20% (11°). When operating on slopes greater than 20%, please, contact the producer.

Tubeless tires – may be used with a tube.

SST



Tractor radial tires

	Tire load capacity (kg) at tire pressure (bar)										Speed (km/h)
	0.4	0.6	0.8	1.0	1.2	1.4	1.6	2.0	2.4	3.0	
2 655		2 425 2 545 3 100	2 640 2 755 2 890 3 520	2 795 2 935 3 060 3 210 3 910	3 050 3 205 3 340 3 510 4 275	3 355 3 525 3 675 3 860 4 695	3 650 3 835 4 000 4 200 5 110	5 475			65 50 40 30 10
3 000		2 740 2 880 3 505	2 985 3 110 3 270 3 980	3 155 3 315 3 455 3 630 4 420	3 450 3 625 3 780 3 970 4 830	3 790 3 980 4 150 4 360 5 310	4 125 4 330 4 500 4 745 5 775	6 190			65 50 40 30 10
4 055		3 715 3 905 4 750	4 055 4 230 4 445 5 410	4 305 4 520 4 715 4 950 6 025	4 295 4 720 4 955 5 170 5 425 6 605	4 575 5 030 5 280 5 510 5 785 7 045	4 825 5 300 5 565 5 800 6 095 7 420	5 285 5 805 6 095 6 355 6 675 8 125	5 600 6 150 6 460 6 700 7 075 8 610	9 225	70 65 50 40 30 10
3 145		2 875 3 015 3 675	3 125 3 260 3 425 4 170	3 310 3 475 3 625 3 805 4 635	3 615 3 795 3 960 4 160 5 065	3 940 4 140 4 315 4 530 5 515	4 250 4 465 4 625 4 890 5 950	4 765 5 005 5 220 5 480 6 675	5 150 5 410 5 600 5 925 7 210	(3.0 bar) 7 725	65 50 40 30 10
4 240		3 885 4 080 4 970	4 245 4 425 4 645 5 655	4 095 4 500 4 725 4 930 5 180 6 305	4 490 4 935 5 180 5 405 5 675 6 910	4 810 5 285 5 550 5 790 6 080 7 400	5 100 5 600 5 880 6 150 6 440 7 840	5 550 6 100 6 405 6 680 7 015 8 540	6 000 6 500 6 825 7 100 7 475 9 100	9 750	70 65 50 40 30 10
4 510		4 130 4 340 5 280	4 510 4 700 4 940 6 010	4 355 4 785 5 025 5 240 5 505 6 700	4 775 5 245 5 510 5 745 6 030 7 345	5 130 5 640 5 925 6 175 6 490 7 900	5 460 6 000 6 300 6 500 6 900 8 400	5 900 6 480 6 805 7 095 7 450 9 070	6 300 6 900 7 245 7 500 7 935 9 660	10 350	70 65 50 40 30 10

kW	22	44	66	88	110	132	150	162	184	>220
hp	30	60	90	120	150	180	200	220	250	>300



AC 65	
LOAD CAPACITY	● ● ● ● ●
TRACTION	● ● ● ● ● ●
SOIL PROTECTION	● ● ● ● ●
HANDLING ON ROAD	● ● ● ● ●

AC 65

Versatile wide tire that delivers efficiency in field applications and in transport



Extremely economical thanks to very good traction and low-wear tread compound.



Very high load-carrying capacity through large volume of air.



Very gentle ground handling thanks to a very large contact patch and exceptional load-carrying capacities.



Greater operator comfort at road speeds as high as 65 km/h.



AC 65

Technical data and load capacities

Tire size	Service description L/SS	Rims * (permitted)	Section width (mm)	Overall diameter (mm)	Loaded static radius (mm)	Rolling circumference (mm)	Speed radius index	
320/65 R 16	117 D (120 A8)	W 10 W 11 W 9	316 326 310	844	373	2 497	390	
420/65 R 20¹⁾	125 D (128 A8)	W 13 W 12 W 11	408 398 388	1 050	469	3 146	500	
420/65 R 20	125 D (128 A8)	W 13 W 12 W 11	415 405 395	1 050	469	3 146	500	
440/65 R 24	128 D (131 A8)	W 14 L W 13 W 12	445 435 425	1 196	543	3 585	575	
480/65 R 24	133 D (136 A8)	W 15 L W 14 L W 13	473 463 453	1 256	570	3 764	600	
540/65 R 24	140 D (143 A8)	W 16 L W 18 L W 15 L	523 543 513	1 317	590	3 922	625	
540/65 R 24	146 D (149 A8)	W 16 L W 18 L W 15 L	523 543 513	1 317	590	3 922	625	
440/65 R 28	131 D (134 A8)	W 14 L W 13 W 12	447 437 427	1 292	594	3 896	625	

¹⁾ Tread pattern AC 65 N



AC 65

	Tire load capacity (kg) at tire pressure (bar)										Speed (km/h)
	0.4	0.6	0.8	1.0	1.2	1.4	1.6	2.0	2.4	3.0	
625		585 615 750	655 685 715 875	715 750 780 820 1 000	800 840 880 920 1 125	890 935 975 1 020 1 245	975 1 025 1 060 1 120 1 365	1 135 1 195 1 245 1 305 1 590	1 285 1 350 1 400 1 480 1 800	1 930	65 50 40 30 10
1 130		1 045 1 095 1 335	1 145 1 195 1 255 1 530	1 225 1 285 1 340 1 410 1 715	1 355 1 420 1 480 1 555 1 895	1 500 1 575 1 645 1 725 2 100	1 650 1 735 1 800 1 900 2 310	2 475			65 50 40 30 10
1 130		1 045 1 095 1 335	1 145 1 195 1 255 1 530	1 225 1 285 1 340 1 410 1 715	1 355 1 420 1 480 1 555 1 895	1 500 1 575 1 645 1 725 2 100	1 650 1 735 1 800 1 900 2 310	2 475			65 50 40 30 10
1 330		1 215 1 280 1 555	1 325 1 380 1 450 1 765	1 400 1 470 1 535 1 610 1 960	1 530 1 610 1 675 1 760 2 145	1 670 1 750 1 830 1 920 2 335	1 800 1 890 1 950 2 070 2 520	2 700			65 50 40 30 10
1 525		1 395 1 465 1 780	1 515 1 580 1 660 2 020	1 605 1 685 1 755 1 845 2 245	1 755 1 840 1 920 2 015 2 455	1 910 2 005 2 090 2 195 2 675	2 060 2 165 2 240 2 370 2 885	3 090			65 50 40 30 10
1 835		1 675 1 760 2 140	1 825 1 900 1 995 2 430	1 930 2 025 2 115 2 220 2 700	2 110 2 215 2 310 2 425 2 950	2 310 2 425 2 525 2 655 3 230	2 500 2 625 2 725 2 875 3 500	3 750			65 50 40 30 10
1 835		1 675 1 760 2 140	1 825 1 900 1 995 2 430	1 930 2 025 2 115 2 220 2 700	2 110 2 215 2 310 2 425 2 950	2 310 2 425 2 525 2 655 3 230	2 500 2 625 2 740 2 875 3 500	2 780 2 915 3 040 3 195 3 890	3 000 3 150 3 250 3 450 4 200	4 500	65 50 40 30 10
1 430		1 305 1 375 1 670	1 425 1 485 1 560 1 895	1 505 1 580 1 650 1 730 2 110	1 645 1 725 1 800 1 890 2 305	1 800 1 890 1 970 2 070 2 520	1 950 2 050 2 120 2 245 2 730	2 925			65 50 40 30 10

AC 65

Technical data and load capacities

Tire size	Service description L/SS	Rims * (permitted)	Section width (mm)	Overall diameter (mm)	Loaded static radius (mm)	Rolling circumference (mm)	Speed radius index	
480/65 R 28	136 D (139 A8)	W 15 L W 14 L W 13	475 465 455	1 355	616	4 064	650	
540/65 R 28	142 D (145 A8)	W 16 L W 18 L W 15 L	530 550 520	1 410	624	4 145	675	
600/65 R 28	147 D (150 A8)	W 18 L DW 20 B W 16 L	590 610 570	1 485	661	4 411	700	
540/65 R 30	150 D (153 A8)	W 16 L W 18 L W 15 L	526 546 516	1 485	664	4 419	700	
600/65 R 30	149 D (152 A8)	W 18 L DW 20 B W 16 L	590 610 570	1 549	687	4 591	725	
540/65 R 34	145 D (148 A8)	W 16 L W 18 L W 15 L	526 546 516	1 580	709	4 709	750	
600/65 R 34	151 D (154 A8)	W 18 L DW 20 B W 16 L	592 612 572	1 648	737	4 904	775	
600/65 R 34	157 D (160 A8)	W 18 L DW 20 B W 16 L	592 612 572	1 648	737	4 904	775	
540/65 R 38	147 D (150 A8)	W 16 L W 18 L W 15 L	517 537 507	1 678	760	5 023	800	



	Tire load capacity (kg) at tire pressure (bar)										Speed (km/h)
	0.4	0.6	0.8	1.0	1.2	1.4	1.6	2.0	2.4	3.0	
1 635		1 495 1 570 1 910	1 625 1 695 1 780 2 165	1 720 1 805 1 885 1 980 2 410	1 880 1 975 2 060 2 160 2 630	2 060 2 165 2 260 2 370 2 885	2 240 2 350 2 430 2 575 3 135	3 360			65 50 40 30 10
1 960		1 790 1 880 2 290	1 950 2 035 2 135 2 600	2 065 2 165 2 260 2 375 2 890	2 255 2 365 2 470 2 595 3 155	2 455 2 580 2 690 2 825 3 440	2 650 2 785 2 900 3 050 3 710	3 975			65 50 40 30 10
2 310		2 110 2 220 2 700	2 300 2 395 2 515 3 065	2 430 2 555 2 665 2 795 3 405	2 660 2 790 2 910 3 055 3 720	2 875 3 020 3 145 3 305 4 025	3 075 3 230 3 350 3 535 4 305	4 615			65 50 40 30 10
2 020		1 850 1 940 2 365	2 010 2 100 2 205 2 680	2 130 2 235 2 330 2 450 2 980	2 325 2 440 2 545 2 675 3 255	2 545 2 675 2 790 2 930 3 565	2 725 2 860 3 000 3 135 3 815	3 080 3 235 3 375 3 545 4 315	3 350 3 520 3 650 3 855	5 025	65 50 40 30 10
2 380		2 175 2 285 2 780	2 370 2 470 2 595 3 160	2 505 2 630 2 745 2 880 3 510	2 740 2 875 3 000 3 150 3 835	3 000 3 150 3 285 3 450 4 200	3 250 3 415 3 550 3 740 4 550	4 875			65 50 40 30 10
2 145		1 960 2 055 2 505	2 130 2 225 2 335 2 845	2 255 2 370 2 470 2 595 3 160	2 465 2 590 2 700 2 835 3 450	2 690 2 820 2 945 3 090 3 765	2 900 3 045 3 150 3 335 4 060	4 350			65 50 40 30 10
2 520		2 300 2 420 2 945	2 505 2 615 2 745 3 340	2 650 2 785 2 905 3 050 3 710	2 900 3 045 3 175 3 330 4 055	3 180 3 335 3 480 3 655 4 450	3 450 3 625 3 750 3 970 4 830	5 175			65 50 40 30 10
2 520		2 300 2 420 2 945	2 505 2 615 2 745 3 340	2 650 2 785 2 905 3 050 3 710	2 900 3 045 3 175 3 330 4 055	3 180 3 335 3 480 3 655 4 450	3 450 3 625 3 750 3 970 4 830	3 875 4 070 4 250 4 455 5 425	4 125 4 330 4 500 4 745 5 775	6 300	65 50 40 30 10
2 260		2 065 2 170 2 640	2 250 2 345 2 465 3 000	2 380 2 500 2 605 2 735 3 330	2 600 2 730 2 850 2 990 3 640	2 845 2 985 3 115 3 270 3 980	3 075 3 230 3 350 3 535 4 305	4 615			65 50 40 30 10

AC 65

Technical data and load capacities

Tire size	Service description L/SS	Rims * (permitted)	Section width (mm)	Overall diameter (mm)	Loaded static radius (mm)	Rolling circumference (mm)	Speed radius index	
600/65 R 38	153 D (156 A8)	W 18 L DW 20 B W 16 L	590 610 570	1 759	792	5 251	825	
650/65 R 38	157 D (160 A8)	DW 20 B DW 21 B DW 18 L	638 648 618	1 828	810	5 416	875	
650/65 R 38	166 D (169 A8)	DW 20 B DW 21 B DW 18 L	640 650 620	1 840	828	5 461	875	
650/65 R 38	173 D (176 A8)	DW 20 B DW 21 B DW 18 L	See page 82					
710/70 R 38	166 D (169 A8)	DW 23 B DW 25 B	708 728	1 925	857	5 716	925	
650/65 R 42	165 D (168 A8)	DW 20 B DW 21 B DW 18 L	641 651 621	1 936	860	5 798	925	

* Additional permitted rims may be available on request

Load values for 0.4 bar and 0.6 bar are for calculating dual and triple load values only.
30 km/h (up to 40 km/h) load values also apply for low-speed high-torque field work.

For plowing with single driven tires in the furrow, a minimum inflation pressure of 0.8 bar is required.

For intensive road transport at 65/50/40/30 km/h the pressure must be increased by 0.4 bar. Maximum inflation pressure should never be exceeded.

All load values are valid for ground slopes up to and including 20% (11°). When operating on slopes greater than 20%, please, contact the producer.

Tubeless tires – may be used with a tube.



AC 65

Tractor radial tires

	Tire load capacity (kg) at tire pressure (bar)										Speed (km/h)
	0.4	0.6	0.8	1.0	1.2	1.4	1.6	2.0	2.4	3.0	
2 655		2 425 2 545 3 100	2 640 2 755 2 890 3 520	2 795 2 935 3 060 3 210 3 910	3 050 3 205 3 340 3 510 4 275	3 355 3 525 3 675 3 860 4 695	3 650 3 835 4 000 4 200 5 110	5 475			65 50 40 30 10
3 000		2 740 2 880 3 505	2 985 3 110 3 270 3 980	3 155 3 315 3 455 3 630 4 420	3 450 3 625 3 780 3 970 4 830	3 790 3 980 4 150 4 360 5 310	4 125 4 330 4 500 4 745 5 775	6 190			65 50 40 30 10
3 000		2 740 2 880 3 505	2 985 3 110 3 270 3 980	3 155 3 315 3 455 3 630 4 420	3 450 3 625 3 780 3 970 4 830	3 790 3 980 4 150 4 360 5 310	4 125 4 330 4 500 4 745 5 775	4 530 4 760 4 960 5 210 6 345	4 875 5 120 5 300 5 605 6 825	(2.8 bar) 5 300 5 565 5 800 6 095 7 420	65 50 40 30 10
3 765		3 445 3 620 4 405	3 755 3 915 4 110 5 005	3 975 4 175 4 350 4 570 5 565	4 345 4 565 4 760 5 000 6 085	4 825 5 065 5 280 5 550 6 755	5 300 5 565 5 800 6 095 7 420	7 950			65 50 40 30 10
3 145		2 875 3 015 3 675	3 125 3 260 3 425 4 170	3 310 3 475 3 625 3 805 4 635	3 615 3 795 3 960 4 160 5 065	3 940 4 140 4 315 4 530 5 515	4 250 4 465 4 625 4 890 5 950	4 765 5 005 5 220 5 480 6 675	5 150 5 410 5 600 5 925 7 210	7 725	65 50 40 30 10

kW	22	44	66	88	110	150	162	191	>220
hp	30	60	90	120	150	200	220	260	>300



HC 70

LOAD CAPACITY	●●●●●
TRACTION	●●●●●
SOIL PROTECTION	●●●●
HANDLING ON ROAD	●●●●

HC 70

The all-round benchmark in the 70 series wide tire segment with higher load capacities than conventional 70 series



Low operating costs thanks to minimised slip, plus gentle ground handling through high load capacity.



Comfortable, safe road performance, thanks to wide tire shoulders.



Particularly **gentle handling of grassland** through rounded shoulder design and lug edges.

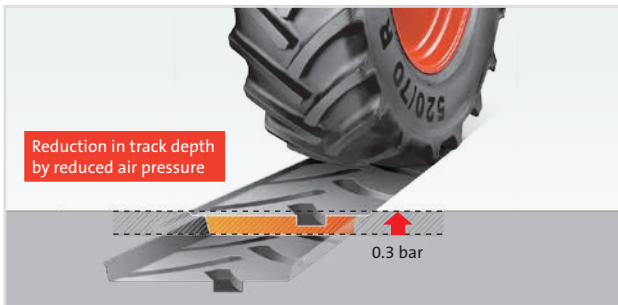

Low track depth and low operating costs, thanks to reduced inflation pressure and good traction.



HC 70

Technical data and load capacities

Tire size	Service description L/SS	Rims * (permitted)	Section width (mm)	Overall diameter (mm)	Loaded static radius (mm)	Rolling circumference (mm)	Speed radius index	
320/70 R 24	116 D (119 A8)	W 10 W 11 W 9	325 335 315	1 115	491	3 295	525	
360/70 R 24	122 D (125 A8)	W 11 W 12 W 10	365 375 355	1 142	508	3 398	550	
380/70 R 24	125 D (128 A8)	W 12 W 13 W 11	395 405 385	1 191	533	3 545	575	
420/70 R 24	130 D (133 A8)	W 13 W 14 L W 12	443 453 433	1 245	552	3 695	600	
480/70 R 24	138 D (141 A8)	W 15 L W 16 L W 14 L	502 512 492	1 320	574	3 896	625	
380/70 R 28	127 D (130 A8)	W 12 W 13 W 11	395 405 385	1 292	576	3 850	625	
420/70 R 28	133 D (136 A8)	W 13 W 14 L W 12	438 448 428	1 350	610	4 038	650	
480/70 R 28	140 D (143 A8)	W 15 L W 16 L W 14 L	498 508 488	1 422	630	4 220	675	
420/70 R 30	134 D (137 A8)	W 13 W 14 L W 12	433 443 423	1 392	622	4 150	675	



HC 70

Tractor radial tires

	Tire load capacity (kg) at tire pressure (bar)										Speed (km/h)
	0.6	0.8	1.0	1.2	1.4	1.6	2.0	2.4	2.8	3.2	
			945	1 035	1 140	1 250					65
		890	990	1 085	1 200	1 315					50
	820	930	1 035	1 190	1 250	1 360					40
	860	975	1 085	1 445	1 315	1 440					30
	1 045	1 190	1 320	2 170	1 600	1 750	1 875				10
			1 130	1 235	1 370	1 500					65
		1 065	1 185	1 295	1 435	1 575					50
	980	1 110	1 235	1 355	1 500	1 650					40
	1 030	1 170	1 300	1 420	1 575	1 725					30
	1 250	1 420	1 580	1 730	1 915	2 100	2 250				10
			1 225	1 340	1 495	1 650					65
		1 160	1 290	1 410	1 570	1 735					50
	1 065	1 210	1 345	1 470	1 640	1 800					40
	1 115	1 270	1 410	1 545	1 720	1 900					30
	1 360	1 545	1 720	1 880	2 095	2 310	2 475				10
			1 430	1 565	1 735	1 900					65
		1 350	1 505	1 645	1 820	1 995					50
	1 240	1 410	1 570	1 715	1 900	2 060					40
	1 305	1 480	1 645	1 800	1 995	2 185					30
	1 585	1 805	2 005	2 190	2 425	2 660	2 850				10
			1 765	1 930	2 145	2 360					65
		1 665	1 850	2 025	2 250	2 480					50
	1 530	1 735	1 930	2 110	2 350	2 575					40
	1 605	1 825	2 030	2 220	2 465	2 715					30
	1 955	2 220	2 470	2 700	3 000	3 305	3 540				10
			1 320	1 445	1 600	1 750					65
		1 245	1 385	1 515	1 675	1 840					50
	1 145	1 300	1 445	1 580	1 750	1 900					40
	1 200	1 365	1 520	1 660	1 835	2 015					30
	1 465	1 660	1 850	2 020	2 335	2 450	2 625				10
			1 535	1 680	1 870	2 060					65
		1 450	1 615	1 765	1 965	2 165					50
	1 335	1 515	1 685	1 840	2 050	2 240					40
	1 400	1 590	1 770	1 935	2 150	2 370					30
	1 705	1 935	2 150	2 355	2 620	2 885	3 090				10
			1 890	2 065	2 285	2 500					65
		1 780	2 980	2 170	2 395	2 625					50
	1 635	1 860	2 065	2 260	2 500	2 725					40
	1 720	1 950	2 170	2 375	2 625	2 875					30
	2 090	2 375	2 645	2 890	3 195	3 500	3 750				10
			1 590	1 735	1 930	2 120					65
		1 500	1 670	1 825	2 025	2 225					50
	1 375	1 565	1 740	1 905	2 110	2 300					40
	1 445	1 645	1 825	2 000	2 220	2 440					30
	1 760	2 000	2 225	2 430	2 700	2 970	3 180				10

HC 70

Technical data and load capacities

Tire size	Service description L/SS	Rims * (permitted)	Section width (mm)	Overall diameter (mm)	Loaded static radius (mm)	Rolling circumference (mm)	Speed radius index
480/70 R 30	141 D (144 A8)	W 15 L W 16 L W 14 L	499 509 489	1 474	655	4 380	700
480/70 R 30	152 D (155 A8)	W 15 L W 16 L W 14 L	499 509 489	1 474	655	4 380	700
480/70 R 34	143 D (146 A8)	W 15 L W 16 L W 14 L	494 504 484	1 590	704	4 710	750
480/70 R 34	155 D (158 A8)	W 15 L W 16 L W 14 L	494 504 484	1 590	704	4 710	750
520/70 R 34	148 D (151 A8)	W 16 L W 18 L W 15 L	539 559 529	1 651	735	4 905	775
480/70 R 38	145 D (148 A8)	W 15 L W 16 L W 14 L	496 506 486	1 699	768	5 082	800
520/70 R 38	150 D (153 A8)	W 16 L W 18 L W 15 L	536 556 524	1 751	790	5 232	825
580/70 R 38	155 D (158 A8)	W 18 L	596	1 857	822	5 500	875

* Additional permitted rims may be available on request

Load values for 0.6 bar are for calculating dual and triple load values only.
30 km/h (up to 40 km/h) load values also apply for low-speed high-torque field work.
For plowing with single driven tires in the furrow, a minimum inflation pressure of 0.8 bar is required.



HC 70

	Tire load capacity (kg) at tire pressure (bar)										Speed (km/h)
	0.6	0.8	1.0	1.2	1.4	1.6	2.0	2.4	2.8	3.2	
1 690 1 775 2 160	1 840 1 920 2 015 2 455	1 950 2 045 2 135 2 240 2 725	2 130 2 235 2 335 2 450 2 985	2 355 2 470 2 580 2 705 3 295	2 575 2 705 2 800 2 960 3 605		3 865				65 50 40 30 10
1 690 1 775 2 160	1 840 1 920 2 015 2 455	1 950 2 045 2 135 2 240 2 725	2 130 2 235 2 335 2 450 2 985	2 355 2 470 2 580 2 705 3 295	2 575 2 705 2 800 2 960 3 605	2 870 3 015 3 145 3 300 4 020	3 075 3 230 3 365 3 535 4 305	3 335 3 500 3 650 3 835 4 670	3 550 3 730 3 875 4 085 4 970	65 50 40 30 10	
1 790 1 880 2 290	1 950 2 035 2 135 2 600	2 065 2 170 2 265 2 895	2 260 2 375 2 475 3 165	2 495 2 620 2 730 3 490	2 725 2 860 3 000 3 135 3 815		4 090				65 50 40 30 10
1 790 1 880 2 290	1 950 2 035 2 135 2 600	2 065 2 170 2 265 2 895	2 260 2 375 2 475 3 165	2 495 2 620 2 730 3 490	2 725 2 860 3 000 3 135 3 815	3 000 3 150 3 250 3 450 4 200	3 250 3 415 3 550 3 740 4 550	3 550 3 730 3 875 4 085 4 970	3 875 4 070 4 250 4 455 5 425	65 50 40 30 10	
2 025 2 125 2 590	2 205 2 300 2 415 2 940	2 335 2 450 2 555 2 685 3 270	2 555 2 680 2 795 2 935 3 575	2 850 2 995 3 120 3 280 3 990	3 150 3 310 3 450 3 625 4 410		4 725				65 50 40 30 10
1 890 1 985 2 420	2 060 2 150 2 255 2 745	2 180 2 290 2 390 3 055	2 385 2 505 2 615 3 340	2 645 2 775 2 895 3 700	2 900 3 045 3 150 3 335 4 060		4 350				65 50 40 30 10
2 135 2 240 2 730	2 325 2 525 2 545 3 100	2 460 2 585 2 695 2 830 3 445	2 695 2 825 2 950 3 095 3 770	3 020 3 170 3 305 3 470 4 225	3 350 3 520 3 650 3 855 4 690		5 025				65 50 40 30 10
2 520 2 645 3 225	2 745 2 865 3 005 3 660	2 910 3 055 3 185 3 345 4 070	3 180 3 340 3 480 3 655 4 450	3 530 3 705 3 865 4 055 4 940	3 875 4 070 4 250 4 455 5 425		5 815				65 50 40 30 10

For intensive road transport at 65/50/40/30 km/h the pressure must be increased by 0.4 bar. Maximum inflation pressure should never be exceeded. All load values are valid for ground slopes up to and including 20% (11°). When operating on slopes greater than 20%, please, contact the producer. Tubeless tires – may be used with a tube.

kW	22	44	66	88	110	132	150	162	184	>220
hp	30	60	90	120	150	180	200	220	250	>300



AC 70 T

LOAD CAPACITY	● ● ● ● ●
TRACTION	● ● ● ● ● ●
SOIL PROTECTION	● ● ● ●
HANDLING ON ROAD	● ● ● ●

AC 70 T

Wide traction tire for heavy field work



Deep lugs provide greater traction **in the field.**



Outstanding self-cleaning between lugs reduces slip and improves pulling power.



Tremendous durability and outstanding traction make this tire very economical.



Standard tire

Mitas AC 70 T

Deep high-grip lugs transmit traction, even on wet ground.

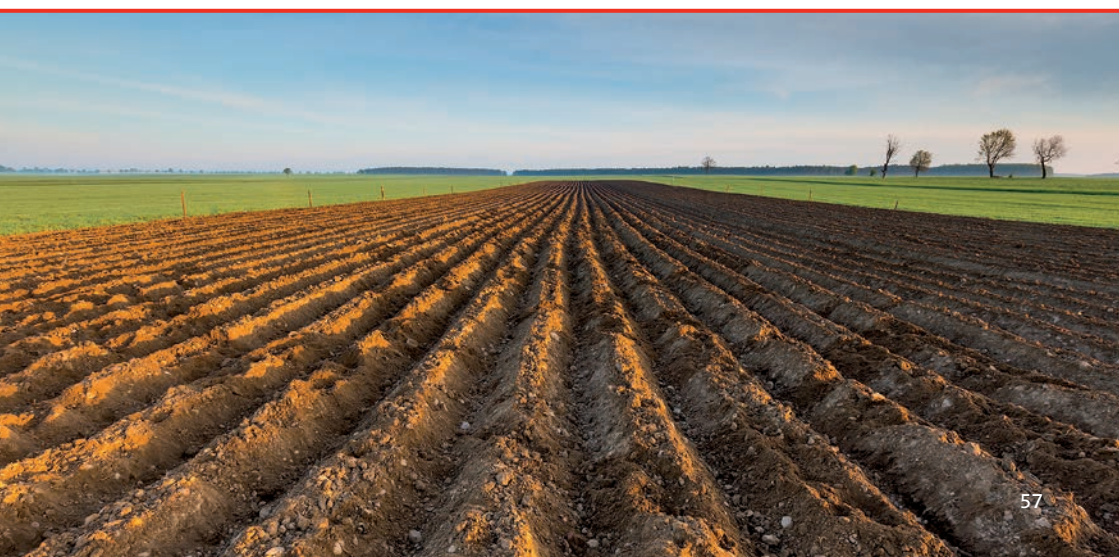

AC 70 T

Technical data and load capacities

Tire size	Service description L/SS	Rims * (permitted)	Section width (mm)	Overall diameter (mm)	Loaded static radius (mm)	Rolling circumference (mm)	Speed radius index	
200/70 R 16	94 A8 (94 B)	W 6 W 8 W 7	198 218 208	691	311	2 050	330	
240/70 R 16	104 A8 (104 B)	W 8 W 9 W 7	244 254 234	737	331	2 192	350	
260/70 R 16	109 A8 (109 B)	W 8 W 9	261 271	770	345	2 290	360	
280/70 R 16	112 A8 (112 B)	W 9 W 10 W 8	285 295 275	798	358	2 390	390	
280/70 R 18	114 A8 (114 B)	W 9 W 10 W 8	280 290 270	852	383	2 545	410	
260/70 R 20	113 A8 (113 B)	W 8 W 9 W 10	262 272 282	882	401	2 650	410	
280/70 R 20	116 A8 (116 B)	W 9 W 10 W 8	276 286 266	906	411	2 725	425	
300/70 R 20	110 A8 (110 B)	W 9 W 10	290 300	942	428	2 825	450	
320/70 R 20	113 A8 (113 B)	W 10 W 11 W 9	320 330 310	972	441	2 916	475	
360/70 R 20	120 A8 (120 B)	W 11 W 12 W 10	360 370 350	1 040	461	3 083	500	



AC 70 T

	Tire load capacity (kg) at tire pressure (bar)									Speed (km/h)
	0.6	0.8	1.0	1.2	1.4	1.6	2.0	2.4	3.0	
			410	445	480	510	565	670		50
		375	410	445	480	510	565	670		40
355	400	440	480	510	545	605	715			30
435	485	535	580	625	660	735	870		1 005	10
			545	590	630	670	745	900		50
	495	545	590	630	670	745	900			40
470	530	580	630	675	720	795	965			30
570	640	705	765	820	870	965	1 170		1 350	10
			615	665	715	760	840	1 030		50
	560	615	665	715	760	840	1 030			40
530	595	660	710	765	810	900	1 100			30
645	725	800	865	930	985	1 095	1 340		1 545	10
			690	750	800	850	940	1 120		50
	625	690	750	800	850	940	1 120			40
600	670	740	800	860	910	1 010	1 200			30
720	815	900	970	1 040	1 110	1 230	1 460		1 680	10
			725	790	845	900	995	1 180		50
	660	725	790	845	900	995	1 180			40
630	705	775	845	905	960	1 065	1 265			30
765	860	945	1 025	1 100	1 165	1 295	1 535		1 770	10
			620	690	770	850	995	1 150		50
	550	620	690	770	850	995	1 150			40
515	590	665	740	825	910	1 065	1 230			30
670	775	870	965	1 080	1 190	1 395	1 610		1 725	10
			765	830	890	945	1 045	1 250		50
	695	765	830	890	945	1 045	1 250			40
660	740	815	885	950	1 010	1 120	1 340			30
805	900	995	1 075	1 155	1 230	1 360	1 625		1 875	10
			850	920	985	1 060				50
	770	850	920	985	1 060					40
735	825	910	985	1 055	1 135					30
890	1 000	1 105	1 200	1 280	1 380		1 590			10
			935	1 015	1 090	1 150				50
	850	935	1 015	1 090	1 150					40
810	910	1 000	1 090	1 165	1 230					30
985	1 105	1 220	1 320	1 420	1 495		1 725			10
			1 125	1 220	1 305	1 400				50
	1 020	1 125	1 220	1 305	1 400					40
975	1 090	1 200	1 305	1 400	1 500					30
1 180	1 330	1 460	1 585	1 700	1 820		2 100			10

AC 70 T

Technical data and load capacities

Tire size	Service description L/SS	Rims * (permitted)	Section width (mm)	Overall diameter (mm)	Loaded static radius (mm)	Rolling circumference (mm)	Speed radius index	
380/70 R 20	122 A8 (122 B)	W 12 W 13 W 11	383 393 373	1 074	478	3 195	525	
320/70 R 24	116 A8 (116 B)	W 10 W 11 W 9	320 330 310	1 095	505	3 276	525	
360/70 R 24	122 A8 (122 B)	W 11 W 12 W 10	360 370 350	1 150	516	3 426	550	
380/70 R 24	125 A8 (125 B)	W 12 W 13 W 11	387 397 377	1 187	538	3 508	575	
420/70 R 24	130 A8 (130 B)	W 13 W 14 L W 12	433 443 423	1 260	563	3 715	600	
380/70 R 28	127 A8 (127 B)	W 12 W 13 W 11	372 382 362	1 274	585	3 835	625	
420/70 R 28	133 A8 (133 B)	W 13 W 14 L W 12	420 430 410	1 350	609	3 988	650	
480/70 R 28	140 A8 (140 B)	W 15 L W 16 L W 14 L	480 490 470	1 415	630	4 206	675	
420/70 R 30	134 A8 (134 B)	W 13 W 14 L W 12	423 433 413	1 395	635	4 184	675	
480/70 R 30	141 A8 (141 B)	W 15 L W 16 L W 14 L	496 506 486	1 477	667	4 435	700	



AC 70 T

	Tire load capacity (kg) at tire pressure (bar)									Speed (km/h)
	0.6	0.8	1.0	1.2	1.4	1.6	2.0	2.4	3.0	
1 060 1 285	1 110 1 190 1 445	1 220 1 220 1 310 1 590	1 325 1 325 1 420 1 725	1 420 1 420 1 520 1 850	1 500 1 500 1 605 1 950		2 250			50 40 30 10
885 1 075	930 995 1 210	1 020 1 020 1 095 1 330	1 110 1 110 1 185 1 440	1 190 1 190 1 270 1 545	1 250 1 250 1 340 1 625		1 875			50 40 30 10
1 055 1 285	1 110 1 185 1 440	1 220 1 220 1 305 1 590	1 325 1 325 1 415 1 720	1 420 1 420 1 520 1 850	1 500 1 500 1 605 1 950		2 250			50 40 30 10
1 150 1 395	1 205 1 290 1 570	1 330 1 330 1 420 1 725	1 440 1 440 1 540 1 870	1 540 1 540 1 650 2 010	1 650 1 650 1 765 2 145		2 475			50 40 30 10
1 340 1 630	1 410 1 505 1 830	1 550 1 550 1 660 2 015	1 680 1 680 1 800 2 180	1 800 1 800 1 930 2 340	1 900 1 900 2 030 2 470		2 850			50 40 30 10
1 235 1 500	1 300 1 390 1 690	1 430 1 430 1 530 1 855	1 550 1 550 1 660 2 010	1 660 1 660 1 775 2 160	1 750 1 750 1 875 2 275		2 625			50 40 30 10
1 440 1 750	1 510 1 620 1 965	1 660 1 660 1 780 2 160	1 800 1 800 1 930 2 345	1 930 1 930 2 070 2 515	2 060 2 060 2 200 2 680		3 090			50 40 30 10
1 770 2 150	1 855 1 985 2 410	2 040 2 040 2 185 2 655	2 215 2 215 2 370 2 880	2 375 2 375 2 540 3 090	2 500 2 500 2 680 3 250		3 750			50 40 30 10
1 490 1 810	1 560 1 670 2 030	1 720 1 720 1 840 2 235	1 865 1 865 1 995 2 420	2 000 2 000 2 140 2 600	2 120 2 120 2 270 2 760		3 180			50 40 30 10
1 820 2 220	1 880 2 010 2 450	2 060 2 060 2 200 2 680	2 240 2 240 2 400 2 910	2 420 2 420 2 590 3 150	2 575 2 575 2 760 3 350		3 860			50 40 30 10

AC 70 T

Technical data and load capacities

Tire size	Service description LI/SS	Rims * (permitted)	Section width (mm)	Overall diameter (mm)	Loaded static radius (mm)	Rolling circumference (mm)	Speed radius index	
480/70 R 34	143 A8 (143 B)	W 15 L W 16 L W 14 L	490 500 480	1 575	710	4 686	750	
520/70 R 34	148 A8 (148 B)	W 16 L W 18 L W 15 L	523 543 513	1 644	734	4 927	775	
480/70 R 38	145 A8 (145 B)	W 15 L W 16 L W 14 L	487 497 477	1 687	767	5 065	800	
520/70 R 38	150 A8 (150 B)	W 16 L W 18 L W 15 L	517 537 507	1 752	788	5 187	825	
580/70 R 38	155 A8 (155 B)	W 18 L	570	1 829	819	5 442	875	

* Additional permitted rims may be available on request

Load values for 0.6 bar are for calculating dual and triple load values only.

30 km/h (up to 40 km/h) load values also apply for low-speed high-torque field work.

For plowing with single driven tires in the furrow, a minimum inflation pressure of 0.8 bar is required.

For intensive road transport at 50/40/30 km/h the pressure must be increased by 0.4 bar. Maximum inflation pressure should never be exceeded.

All load values are valid for ground slopes up to and including 20% (11°). When operating on slopes greater than 20%, please, contact the producer.

Tubeless tires – may be used with a tube.



AC 70 T

	Tire load capacity (kg) at tire pressure (bar)									Speed (km/h)
	0.6	0.8	1.0	1.2	1.4	1.6	2.0	2.4	3.0	
1 935 2 350	2 030 2 170 2 640	2 235 2 235 2 390 2 905	2 425 2 425 2 595 3 150	2 600 2 600 2 780 3 380	2 725 2 725 2 915 3 545		4 090			50 40 30 10
2 185 2 655	2 295 2 455 2 980	2 525 2 525 2 700 3 285	2 740 2 740 2 930 3 560	2 935 2 935 3 140 3 820	3 150 3 150 3 370 4 095		4 725			50 40 30 10
2 045 2 480	2 145 2 290 2 790	2 360 2 360 2 525 3 070	2 560 2 560 2 740 3 330	2 745 2 745 2 935 3 570	2 900 2 900 3 100 3 770		4 350			50 40 30 10
2 300 2 800	2 380 2 550 3 090	2 600 2 600 2 780 3 380	2 830 2 830 3 030 3 680	3 060 3 060 3 270 3 980	3 350 3 350 3 590 4 360		5 030			50 40 30 10
2 720 3 310	2 855 3 060 3 715	3 145 3 145 3 365 4 090	3 410 3 410 3 650 4 435	3 655 3 655 3 915 4 755	3 875 3 875 4 145 5 040		5 815			50 40 30 10

kW	22	44	66	88	110	132	150	162	184	>220
hp	30	60	90	120	150	180	200	220	250	>300



AC 70 G

LOAD CAPACITY	● ● ● ● ●
TRACTION	● ● ● ● ●
SOIL PROTECTION	● ● ● ●
HANDLING ON ROAD	● ● ● ● ●

AC 70 G

Wide grassland tire with optimum road characteristics



The large, wide lug areas **protect ground and plants**.



Stable, safe and comfortable running on the road, thanks to a wide tread area and large lug overlap in the tread centre.



Economical thanks to low wear.



Large, wide lug areas mean quiet running on the road and gentle driving over grassland.

- Conventional profile design
- AC 70 G Tread pattern



AC 70 G

Technical data and load capacities

Tire size	Service description LI/SS	Rims * (permitted)	Section width (mm)	Overall diameter (mm)	Loaded static radius (mm)	Rolling circumference (mm)	Speed radius index	
380/70 R 24	125 A8 (125 B)	W 12 W 13 W 11	385 395 375	1 190	540	3 524	575	
420/70 R 24	130 A8 (130 B)	W 13 W 14 L W 12	435 445 425	1 248	561	3 708	600	
480/70 R 24	138 A8 (138 B)	W 15 L W 16 L W 14 L	483 493 473	1 313	582	3 908	625	
420/70 R 28	133 A8 (133 B)	W 13 W 14 L W 12	425 435 415	1 348	604	4 027	650	
480/70 R 30	141 A8 (141 B)	W 15 L W 16 L W 14 L	485 495 475	1 462	653	4 345	700	
480/70 R 34	143 A8 (143 B)	W 15 L W 16 L W 14 L	486 496 476	1 580	716	4 711	750	
520/70 R 34	148 A8 (148 B)	W 16 L W 18 L W 15 L	539 559 529	1 649	740	4 930	775	
520/70 R 38	150 A8 (150 B)	W 16 L W 18 L W 15 L	530 550 520	1 747	782	5 230	825	

* Additional permitted rims may be available on request

Load values for 0.6 bar are for calculating dual and triple load values only.

30 km/h (up to 40 km/h) load values also apply for low-speed high-torque field work.

For plowing with single driven tires in the furrow, a minimum inflation pressure of 0.8 bar is required.

For intensive road transport at 50/40/30 km/h the pressure must be increased by 0.4 bar. Maximum inflation pressure should never be exceeded.

All load values are valid for ground slopes up to and including 20% (11°). When operating on slopes greater than 20%, please, contact the producer.

Tubeless tires – may be used with a tube.



AC 70 G

	Tire load capacity (kg) at tire pressure (bar)							Speed (km/h)
	0.6	0.8	1.0	1.2	1.4	1.6	2.0	
1 150 1 400	1 205 1 290 1 570	1 325 1 325 1 420 1 725	1 440 1 440 1 540 1 870	1 540 1 540 1 650 2 005	1 650 1 650 1 770 2 145		2 475	50 40 30 10
1 340 1 630	1 405 1 505 1 830	1 550 1 550 1 660 2 015	1 680 1 680 1 800 2 185	1 800 1 800 1 930 2 310	1 900 1 900 2 035 2 470		2 850	50 40 30 10
1 650 2 005	1 730 1 855 2 250	1 905 1 905 2 040 2 480	2 065 2 065 2 215 2 690	2 215 2 215 2 375 2 885	2 360 2 360 2 525 3 070		3 540	50 40 30 10
1 440 1 750	1 510 1 615 1 965	1 660 1 660 1 780 2 160	1 805 1 805 1 930 2 345	1 930 1 930 2 070 2 515	2 060 2 060 2 205 2 680		3 090	50 40 30 10
1 825 2 215	1 915 2 050 2 490	2 105 2 105 2 255 2 740	2 285 2 285 2 445 2 970	2 450 2 450 2 620 3 185	2 575 2 575 2 755 3 350		3 865	50 40 30 10
1 935 2 350	2 030 2 170 2 640	2 235 2 235 2 390 2 905	2 425 2 425 2 595 3 150	2 600 2 600 2 780 3 380	2 725 2 725 2 915 3 545		4 090	50 40 30 10
2 185 2 655	2 290 2 455 2 985	2 525 2 525 2 700 3 285	2 740 2 740 2 930 3 560	2 935 2 935 3 140 3 820	3 150 3 150 3 370 4 095		4 725	50 40 30 10
2 305 2 800	2 420 2 590 3 145	2 660 2 660 2 850 3 460	2 885 2 885 3 090 3 755	3 095 3 095 3 315 4 025	3 350 3 350 3 585 4 355		5 025	50 40 30 10

kW	22	44	66	88	110	132	150	162	184	>220
hp	30	60	90	120	150	180	200	220	250	>300



AC 85

LOAD CAPACITY	● ● ●
TRACTION	● ● ● ● ●
SOIL PROTECTION	● ● ●
HANDLING ON ROAD	● ● ● ●

AC 85

Modern design delivers outstanding performance, traction, durability, and long tire life



Outstanding long tire life thanks to the use of a wear-resistant tread compound.



Durable radial tire with balanced characteristics for a wide range of applications both in the field and on the road.



Large contact patch enhances **traction**.



AC 85

Technical data and load capacities

Tire size	Service description L/SS	Rims * (permitted)	Section width (mm)	Overall diameter (mm)	Loaded static radius (mm)	Rolling circumference (mm)	Speed radius index	
280/85 R 20 (11.2 R 20)	112 A8 (112 B)	W 10 W 9	299 289	981	444	2 934	475	
320/85 R 20 (12.4 R 20)	119 A8 (119 B)	W 10 W 9 W 11	334 324 344	1 050	465	3 115	500	
280/85 R 24 (11.2 R 24)	115 A8 (115 B)	W 10 W 9	296 286	1 090	497	3 267	525	
320/85 R 24 (12.4 R 24)	122 A8 (122 B)	W 11 W 10 W 9	343 333 323	1 158	530	3 484	550	
340/85 R 24 (13.6 R 24)	125 A8 (125 B)	W 12 W 11	372 362	1 189	536	3 552	575	
380/85 R 24 (14.9 R 24)	131 A8 (131 B)	W 12 W 13 W 11	402 412 392	1 258	563	3 745	600	
420/85 R 24 (16.9 R 24)	137 A8 (137 B)	W 15 W 14 W 13	475 465 455	1 320	591	3 930	625	
280/85 R 28 (11.2 R 28)	118 A8 (118 B)	W 10 W 9	298 288	1 190	551	3 582	575	
320/85 R 28 (12.4 R 28)	124 A8 (124 B)	W 11 W 10 W 9	329 319 309	1 259	578	3 793	600	
340/85 R 28 (13.6 R 28)	127 A8 (127 B)	W 12 W 11	367 357	1 299	587	3 885	625	



AC 85

Tractor radial tires

	Tire load capacity (kg) at tire pressure (bar)										Speed (km/h)
	0.6	0.8	1.0	1.2	1.4	1.6	2.0	2.4	3.0	3.6	
			900	980	1 050	1 120					50
		820	900	980	1 050	1 120					40
780		880	970	1 050	1 125	1 200					30
950	1 070	1 175	1 275	1 365	1 455		1 680				10
			1 000	1 120	1 240	1 360					50
		875	1 000	1 120	1 240	1 360					40
805		935	1 070	1 200	1 325	1 455					30
975	1 140	1 300	1 455	1 610	1 770		2 040				10
			980	1 070	1 140	1 215					50
		890	980	1 070	1 140	1 215					40
850		960	1 050	1 140	1 220	1 300					30
1 030	1 160	1 280	1 390	1 490	1 580		1 825				10
			1 205	1 305	1 400	1 500					50
		1 095	1 205	1 305	1 400	1 500					40
1 045		1 175	1 290	1 400	1 500	1 605					30
1 270	1 425	1 570	1 700	1 825	1 950		2 250				10
			1 325	1 435	1 540	1 650					50
		1 205	1 325	1 435	1 540	1 650					40
1 145		1 290	1 420	1 535	1 650	1 765					30
1 395	1 565	1 720	1 870	2 005	2 145		2 475				10
			1 575	1 710	1 830	1 950					50
		1 430	1 575	1 710	1 830	1 950					40
1 365		1 530	1 685	1 830	1 960	2 090					30
1 660	1 860	2 050	2 220	2 380	2 535		2 925				10
			1 845	2 000	2 145	2 300					50
		1 675	1 845	2 000	2 145	2 300					40
1 595		1 795	1 970	2 140	2 295	2 460					30
1 940	2 175	2 395	2 600	2 790	2 990		3 450				10
			1 060	1 150	1 235	1 320					50
		965	1 060	1 150	1 235	1 320					40
920		1 030	1 135	1 230	1 320	1 410					30
1 120	1 255	1 380	1 495	1 605	1 715		1 980				10
			1 295	1 405	1 510	1 600					50
		1 180	1 295	1 405	1 510	1 600					40
1 125		1 260	1 385	1 505	1 615	1 710					30
1 365	1 530	1 685	1 830	1 960	2 080		2 400				10
			1 425	1 540	1 655	1 750					50
		1 295	1 425	1 540	1 655	1 750					40
1 230		1 380	1 520	1 650	1 770	1 875					30
1 500	1 680	1 850	2 005	2 150	2 275		2 625				10

AC 85

Technical data and load capacities

Tire size	Service description L/SS	Rims * (permitted)	Section width (mm)	Overall diameter (mm)	Loaded static radius (mm)	Rolling circumference (mm)	Speed radius index	
380/85 R 28 (14.9 R 28)	133 A8 (133 B)	W 12 W 13 W 11	401 411 391	1 362	608	4 050	650	
420/85 R 28 (16.9 R 28)	139 A8 (139 B)	W 15 W 14 W 13	459 449 439	1 431	641	4 262	675	
380/85 R 30 (14.9 R 30)	135 A8 (135 B)	W 12 W 13 W 11	398 408 388	1 427	641	4 255	675	
420/85 R 30 (16.9 R 30)	140 A8 (140 B)	W 15 W 14 W 13	472 462 452	1 478	666	4 414	700	
420/90 R 30	147 A8 (147 B)	W 13 W 14	434 444	1 529	681	4 520	725	
460/85 R 30 (18.4 R 30)	145 A8 (145 B)	W 16 W 15 W 14	516 506 496	1 546	697	4 618	725	
380/85 R 34 (14.9 R 34)	146 A8 (146 B)	W 12 W 13 W 11	401 411 391	1 538	699	4 577	725	
420/85 R 34 (16.9 R 34)	142 A8 (142 B)	W 15 W 14 W 13	471 461 451	1 598	724	4 761	750	
420/85 R 34 (16.9 R 34)	147 A8 (147 B)	W 15 W 14 W 13	469 459 449	1 593	722	4 755	750	
460/85 R 34 (18.4 R 34)	147 A8 (147 B)	W 16 W 15 W 14	518 508 498	1 676	756	4 982	775	
340/85 R 38 (13.6 R 38)	133 A8 (133 B)	W 12 W 11	365 355	1 562	719	4 685	750	



AC 85

	Tire load capacity (kg) at tire pressure (bar)										Speed (km/h)
	0.6	0.8	1.0	1.2	1.4	1.6	2.0	2.4	3.0	3.6	
1 460 1 775	1 535 1 640 1 995	1 690 1 690 1 800 2 195	1 830 1 830 1 960 2 380	1 965 1 965 2 100 2 550	2 060 2 060 2 205 2 680		3 090				50 40 30 10
1 705 2 070	1 790 1 915 2 325	1 970 1 970 2 110 2 560	2 135 2 135 2 290 2 780	2 290 2 290 2 450 2 980	2 430 2 430 2 600 3 160		3 645				50 40 30 10
1 510 1 835	1 585 1 695 2 060	1 740 1 740 1 865 2 265	1 890 1 890 2 020 2 460	2 025 2 025 2 170 2 635	2 180 2 180 2 335 2 835		3 270				50 40 30 10
1 760 2 140	1 845 1 975 2 400	2 030 2 030 2 175 2 640	2 205 2 205 2 360 2 865	2 365 2 365 2 530 3 075	2 500 2 500 2 675 3 250		3 750				50 40 30 10
1 540 1 875	1 680 1 800 2 185	1 920 1 920 2 055 2 500	2 160 2 160 2 315 2 810	2 405 2 405 2 575 3 125	2 650 2 650 2 835 3 445	2 895 2 895 3 095 3 760	3 075 3 075 3 290 4 000		4 615		50 40 30 10
2 030 2 460	2 130 2 280 2 760	2 340 2 340 2 510 3 040	2 540 2 540 2 720 3 300	2 720 2 720 2 910 3 540	2 900 2 900 3 100 3 770		4 350				50 40 30 10
1 600 1 945	1 680 1 800 2 185	1 850 1 850 1 980 2 405	2 005 2 005 2 145 2 610	2 150 2 150 2 300 2 795	2 290 2 290 2 450 2 970	2 535 2 535 2 710 3 295	3 000 3 000 3 210 3 900		4 500		50 40 30 10
1 865 2 265	1 955 2 095 2 545	2 155 2 155 2 305 2 800	2 335 2 335 2 500 3 035	2 505 2 505 2 680 3 255	2 650 2 650 2 835 3 445		3 975				50 40 30 10
1 865 2 265	1 955 2 095 2 545	2 155 2 155 2 305 2 800	2 335 2 335 2 500 3 035	2 505 2 505 2 680 3 255	2 650 2 650 2 835 3 445	2 905 2 905 3 110 3 775	3 075 3 075 3 290 4 000		4 615		50 40 30 10
2 145 2 605	2 250 2 405 2 925	2 475 2 475 2 650 3 220	2 685 2 685 2 875 3 490	2 880 2 880 3 080 3 745	3 075 3 075 3 290 4 000		4 615				50 40 30 10
1 430 1 740	1 500 1 605 1 955	1 655 1 655 1 770 2 150	1 795 1 795 1 920 2 335	1 925 1 925 2 060 2 500	2 060 2 060 2 205 2 680		3 090				50 40 30 10

AC 85

Technical data and load capacities

Tire size	Service description LI/SS	Rims * (permitted)	Section width (mm)	Overall diameter (mm)	Loaded static radius (mm)	Rolling circumference (mm)	Speed radius index	
380/80 R 38 (14.9 R 38)	142 A8 (142 B)	W 12 W 11 W 13	380 370 390	1 590	730	4 790	750	
380/95 R 38	147 D (150 A8)	W 12 W 11 W 13	380 370 390	1 680	770	5 050	800	
420/85 R 38 (16.9 R 38)	144 A8 (144 B)	W 15 W 14 W 13	469 459 449	1 696	772	5 088	800	
460/85 R 38 (18.4 R 38)	149 A8 (149 B)	W 16 W 15 W 14	508 498 488	1 768	805	5 280	825	
520/85 R 38 (20.8 R 38)	155 A8 (155 B)	W 16 W 18	545 565	1 857	827	5 515	875	
520/85 R 38 (20.8 R 38)	169 A8 (169 B)	W 16 W 18	539 559	1 877	830	5 520	875	
480/80 R 42 (18.4 R 42)	151 A8 (151 B)	W 16 W 15 W 14	513 503 495	1 850	835	5 540	875	
520/85 R 42 (20.8 R 42)	162 A8 (162 B)	W 16 W 18	537 557	1 966	896	5 878	925	
520/85 R 42 (20.8 R 42)	170 A8 (170 B)	W 16 W 18	542 562	1 983	896	5 878	925	
480/80 R 46 (18.4 R 46)	158 A8 (158 B)	W 16 W 15 W 14	507 497 487	1 960	896	5 886	925	



AC 85

Tractor radial tires

	Tire load capacity (kg) at tire pressure (bar)										Speed (km/h)
	0.6	0.8	1.0	1.2	1.4	1.6	2.0	2.4	3.0	3.6	
			1 720	1 880	2 090	2 300	2 505	2 650			50
		1 545	1 720	1 880	2 090	2 300	2 505	2 650			40
	1 455	1 655	1 840	2 010	2 235	2 460	2 680	2 835			30
	1 770	2 010	2 235	2 440	2 715	2 990	3 255	3 445	3 900		10
			1 985	2 170	2 410	2 650	2 900	3 075			65
		1 875	2 085	2 280	2 530	2 785	3 045	3 230			50
		1 955	2 170	2 375	2 640	2 900	3 175	3 350			40
		2 050	2 280	2 495	2 770	3 050	3 335	3 535			30
		2 495	2 775	3 035	3 375	3 710	4 060	4 305	4 615		10
			2 270	2 465	2 640	2 800					50
		2 065	2 270	2 465	2 640	2 800					40
	1 965	2 210	2 430	2 635	2 830	3 000					30
	2 390	2 685	2 955	3 205	3 435	3 640	4 200				10
		2 370	2 605	2 830	3 030	3 250					50
	2 255	2 535	2 790	3 030	3 245	3 250					40
	2 745	3 080	3 390	3 680	3 945	4 225	4 875				30
			3 150	3 415	3 660	3 875					10
		2 860	3 150	3 415	3 660	3 875					50
	2 725	3 060	3 370	3 655	3 920	4 145					40
	3 310	3 720	4 090	4 440	4 760	5 040	5 815				30
				3 415	3 645	3 875	4 250	4 500	5 225		10
				3 415	3 645	3 875	4 250	4 500	5 225	5 800	50
				3 655	3 900	4 145	4 550	4 815	5 590	5 800	40
				4 440	4 740	5 040	5 525	5 850	6 793	6 205	30
										7 540	10
		2 305	2 565	2 805	3 125	3 450					50
	2 170	2 465	2 565	2 805	3 125	3 450					40
	2 840	3 230	2 745	3 000	3 345	3 690	5 175				30
			3 590	3 925	4 375	4 830					10
		2 995	3 300	3 575	3 840	4 075	4 520	4 750			50
	2 860	3 205	3 300	3 575	3 840	4 075	4 520	4 750			40
	3 470	3 895	3 530	3 825	4 100	4 360	4 835	5 085			30
			4 285	4 650	4 990	5 300	5 875	6 175	7 125		10
				3 350	3 735	4 125	4 500	4 750	5 375		50
				3 350	3 735	4 125	4 500	4 750	5 375	6 000	40
				3 585	4 000	4 415	4 815	5 085	5 750	6 000	30
				4 355	4 860	5 365	5 850	6 175	6 985	6 420	10
										7 800	10
		2 410	2 685	2 935	3 245	3 550	3 960	4 250			50
	2 270	2 580	2 685	2 935	3 245	3 550	3 960	4 250			40
	2 760	3 135	2 870	3 140	3 470	3 800	4 240	4 550			30
			3 485	3 815	4 215	4 615	5 545	5 950	6 300		10

AC 85

Technical data and load capacities

Tire size	Service description L/SS	Rims * (permitted)	Section width (mm)	Overall diameter (mm)	Loaded static radius (mm)	Rolling circumference (mm)	Speed radius index	
520/85 R 46 (20.8 R 46)	158 A8 (158 B)	W 16 W 18	545 565	2 043	930	6 131	975	
380/90 R 50 (14.9 R 50)	151 A8 (151 B)	W 12 W 13 W 11	380 390 370	1 949	888	5 850	950	
480/80 R 50	159 A8 (159 B)	W 16 W 15 W 14	495 485 475	2 065	945	6 210	975	
480/95 R 50	164 D (167 A8)	W 16 W 15 W 14	498 488 478	2 135	968	6 450	1 050	

* Additional permitted rims may be available on request

Load values for 0.6 bar are for calculating dual and triple load values only.

30 km/h (up to 40 km/h) load values also apply for low-speed high-torque field work.

For plowing with single driven tires in the furrow, a minimum inflation pressure of 0.8 bar is required.

For intensive road transport at 65/50/40/30 km/h the pressure must be increased by 0.4 bar. Maximum inflation pressure should never be exceeded.

All load values are valid for ground slopes up to and including 20% (11°). When operating on slopes greater than 20%, please, contact the producer.

Tubeless tires – may be used with a tube.



AC 85

Tractor radial tires

	Tire load capacity (kg) at tire pressure (bar)										Speed (km/h)	
	0.6	0.8	1.0	1.2	1.4	1.6	2.0	2.4	3.0	3.6		
			3 445	3 735	4 005	4 250						50
		3 130	3 445	3 735	4 005	4 250						40
	2 785	3 350	3 685	4 000	4 290	4 550						30
	3 625	4 070	4 480	4 855	5 210	5 525	6 375					10
			2 180	2 385	2 640	2 900	3 215	3 450				50
		1 960	2 180	2 385	2 640	2 900	3 215	3 450				40
	1 845	2 095	2 330	2 550	2 825	3 105	3 440	3 690				30
	2 415	2 745	3 050	3 335	3 700	4 060	4 505	4 830	5 175			10
			2 800	3 060	3 405	3 750	4 105	4 375				50
		2 515	2 800	3 060	3 405	3 750	4 105	4 375				40
	2 370	2 695	2 995	3 275	3 645	3 830	4 395	4 680				30
	3 100	3 525	3 920	4 285	4 765	5 010	5 750	6 125	6 565			10
			3 220	3 530	3 950	4 375	4 715	5 000				65
		3 050	3 390	3 710	4 150	4 590	4 955	5 250				50
		3 180	3 535	3 865	4 325	4 750	5 165	5 450				40
		3 340	3 715	4 060	4 545	5 030	5 425	5 750				30
		4 065	4 520	4 945	4 860	6 120	6 605	7 000	7 500			10



AC 85	
LOAD CAPACITY	● ● ●
TRACTION	● ● ● ●
CROP PROTECTION	● ● ● ● ●
HANDLING ON ROAD	● ● ●



AC 90	
LOAD CAPACITY	● ● ●
TRACTION	● ● ● ●
CROP PROTECTION	● ● ● ● ●
HANDLING ON ROAD	● ● ●

AC 85 / AC 90 Row Crop

Narrow tires developed specially for row cultivation



Reduced tire width eases driving between plants without causing damage, contributing to higher yields. Rounded shoulders, lugs and tire height also protect crops.



Cost-efficient thanks to durable construction that offers high load capacity and transport speeds up to 65 km/h.



Deep lugs provide **excellent traction**, better directional stability and a high level of control.



Good self-cleaning properties help keep the tread pattern free of mud, resulting in less slip, even in difficult conditions.

AC 85 / AC 90 vs. standard size tires

Narrow Row Crop tires were specially developed for driving between rows without damaging the seeds, roots and plants. They are suitable for line weeding, crop cultivation, fertilising, spraying and other agricultural activities.

Reduced tire width



Tractor fitted
with Mitas narrow tires

Tractor fitted
with wide tread-width tires

Rounded lugs

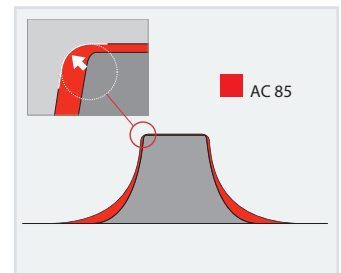

Row Crop

Technical data and load capacities

Tire size	Tread pattern	Service description L/SS	Rims * (permitted)	Section width (mm)	Overall diameter (mm)	Loaded static radius (mm)	Rolling circumference (mm)	Speed radius index	
270/80 R 32 (repl. 9.5 R 32)	AC 90	131 A8 (128 B)	W 9 W 10 W 8	270 280 260	1 225	563	3 690	600	
270/95 R 32	AC 85	136 A8 (136 B)	W 9 W 10 W 8	290 300 280	1 348	619	4 015	625	
320/85 R 32 (repl. 12.4 R 32)	AC 85	142 A8 (142 B)	W 10 W 11 W 9	309 319 299	1 365	625	4 035	650	
320/85 R 32 (repl. 12.4 R 32)	AC 85	145 A8 (145 B)	W 10 W 11 W 9	317 327 307	1 368	625	4 035	650	
320/90 R 32	AC 85	134 A8 (134 B)	W 10 W 11 W 9	331 341 321	1 391	638	4 190	675	
320/85 R 34 (repl. 12.4 R 34)	AC 85	133 A8 (133 B)	W 10 W 11 W 9	326 336 316	1 430	650	4 285	675	
270/80 R 36 (repl. 9.5 R 36)	AC 90	134 A8 (131 B)	W 9 W 10 W 8	270 280 260	1 345	623	4 015	650	

Row Crop

Technical data and load capacities

Tire size	Tread pattern	Service description LI/SS	Rims * (permitted)	Section width (mm)	Overall diameter (mm)	Loaded static radius (mm)	Rolling circumference (mm)	Speed radius index	
13.6 R 36	AC 90	127 A8 (124 B)	W 12 W 11	360 350	1 499	692	4 492	725	
320/85 R 38 (repl. 12.4 R 38)	AC 85	143 A8 (143 B)	W 10 W 11 W 9	322 332 312	1 518	701	4 580	725	
340/85 R 38 (repl. 13.6 R 38)	AC 85	148 A8 (148 B)	W 11 W 12	355 365	1 562	719	4 685	750	
650/65 R 38	AC 65	173 D (176 A8)	W 18 L DW 18 L DW 20 B DW 21 B	635 635 655 665	1 840	828	5 461	875	
300/85 R 42 (repl. 11.2 R 42)	AC 90	144 A8 (141 B)	W 9 W 10 W 11	288 298 308	1 574	740	4 715	750	
300/95 R 42 (repl. 12.4 R 42)	AC 90	147 A8 (144 B)	W 9 W 10 W 11	296 306 316	1 617	753	4 904	775	
320/90 R 42	AC 85	151 A8 (151 B)	W 10 W 11 W 9	319 329 309	1 643	765	4 970	800	



AC 65

AC 85

AC 90

	Tire load capacity (kg) at tire pressure (bar)									Speed (km/h)
	1.2	1.6	2.0	2.4	2.8	3.2	3.6	4.0	4.4	
1 300	1 600									50
1 430	1 750									40
1 530	1 870									30
1 760	2 150									20
1 860	2 280	2 630								10
1 990	2 440	2 830								10 Cyclic
1 530	1 850	2 050	2 180	2 395	2 585	2 725				50
1 635	1 850	2 050	2 180	2 395	2 585	2 725				40
1 880	1 980	2 195	2 335	2 560	2 765	2 915				30
2 140	2 275	2 520	2 680	2 945	3 175	3 350				20
2 445	2 590	2 870	3 050	3 350	3 715	3 815	4 065			10
	2 960	3 280	3 490	3 590	4 135	4 360	4 645			10 Cyclic
1 795	2 060	2 230	2 360	2 620	2 825	3 010	3 150			50
1 920	2 060	2 230	2 360	2 620	2 825	3 010	3 150			40
2 205	2 205	2 385	2 525	2 800	3 025	3 225	3 370			30
2 515	2 535	2 745	2 905	3 220	3 475	3 705	3 875			20
2 695	2 885	3 125	3 305	3 665	3 955	4 215	4 410	4 650		10
	3 090	3 345	3 540	3 930	4 240	4 520	4 725	4 980		10 Cyclic
3 450	4 125	4 530	4 875	5 300	5 800	6 150	6 500			65
3 625	4 330	4 760	5 120	5 565	6 090	6 460	6 825			50
3 780	4 500	4 960	5 300	5 800	6 300	6 700	7 100			40
3 970	4 745	5 210	5 605	6 095	6 670	7 075	7 475			30
4 245	5 075	5 570	5 995	6 520	7 135	7 565	7 995			20
4 830	5 775	6 345	6 825	7 420	8 120	8 610	9 100			10
5 520	6 600	7 250	7 800	8 480	9 280	9 840	10 400			10 Cyclic
1 465	1 630	1 790	1 905	2 090	2 260	2 410	2 575			50
1 570	1 790	1 965	2 095	2 300	2 485	2 650	2 800			40
1 805	1 920	2 105	2 240	2 460	2 655	2 835	2 995			30
2 055	2 205	2 420	2 575	2 825	3 055	3 260	3 445			20
2 200	2 510	2 755	2 935	3 215	3 470	3 695	3 920	4 105		10
	2 690	2 950	3 145	3 445	3 725	3 975	4 200	4 395		10 Cyclic
1 605	1 785	1 955	2 085	2 290	2 475	2 645	2 800			50
1 715	1 960	2 150	2 290	2 515	2 720	2 905	3 075			40
1 970	2 095	2 300	2 450	2 690	2 910	3 110	3 290			30
2 245	2 410	2 645	2 815	3 095	3 345	3 575	3 780			20
2 405	2 745	3 010	3 205	3 520	3 810	4 070	4 305	4 515		10
	2 940	3 225	3 425	3 770	4 080	4 360	4 615	4 835		10 Cyclic
1 700	2 060	2 240	2 430	2 650	2 900	3 075	3 250	3 450		50
1 700	2 060	2 240	2 430	2 650	2 900	3 075	3 250	3 450		40
1 820	2 205	2 395	2 600	2 835	3 100	3 290	3 480	3 690		30
2 090	2 535	2 755	2 990	3 260	3 570	3 780	4 000	4 245		20
2 380	2 885	3 135	3 400	3 710	4 060	4 305	4 550	4 830		10
2 550	3 090	3 360	3 645	3 975	4 350	4 615	4 875	5 175		10 Cyclic

Row Crop

Technical data and load capacities

Tire size	Tread pattern	Service description LI/SS	Rims * (permitted)	Section width (mm)	Overall diameter (mm)	Loaded static radius (mm)	Rolling circumference (mm)	Speed radius index	
IF 320/90 R 42	AC 85	155 B	DW 11 DW 10	331 321	1 640	752	4 930	800	
320/95 R 46	AC 85	152 A8 (152B)	W 10 W 11 W 9	330 340 320	1 770	806	5 298	850	
380/90 R 46 (repl. 14.9 R 46)	AC 85	149 A8 (149 B)	W 12 W 13 W 11	392 402 382	1 844	846	5 542	900	
380/90 R 46 (repl. 14.9 R 46)	AC 85	159 A8 (159 B)	W 12 W 13 W 11	392 402 382	1 844	846	5 542	900	
270/95 R 48 (repl. 11.2 R 48)	AC 90	144 A8 (141 B)	W 9 W 10 W 8	277 287 267	1 737	810	5 220	850	
340/90 R 48 (repl. 13.6 R 48)	AC 85	154 A8 (154 B)	W 11 W 12	348 358	1 825	843	5 481	875	
320/90 R 50	AC 85	150 A8 (150 B)	W 11 W 9 W 10	325 305 315	1 870	873	5 680	900	

Row Crop

Technical data and load capacities

Tire size	Tread pattern	Service description LI/SS	Rims * (permitted)	Section width (mm)	Overall diameter (mm)	Loaded static radius (mm)	Rolling circumference (mm)	Speed radius index	
380/90 R 50 (repl. 14.9 R 50)	AC 85	160 A8 (160 B)	W 12 W 13 W 11	380 390 370	1 949	888	5 850	950	
320/90 R 54	AC 85	151 A8 (151 B)	W 11 W 9 W 10	325 305 315	1 970	917	5 940	950	
380/90 R 54	AC 85	152 A8 (152 B)	W 12 W 13 W 11	380 390 370	2 056	945	6 200	1 000	
380/105 R 54	AC 85	162 D (164 B)	W 12 W 11 W 13	390 380 400	2 160	985	6 520	1 050	

* Additional permitted rims may be available on request

30 km/h (up to 40 km/h) load values also apply for low-speed high-torque field work.

For plowing with single driven tires in the furrow, a minimum inflation pressure of 0.8 bar is required.

For intensive road transport at 50/40/30 km/h the pressure must be increased by 0.4 bar. Maximum inflation pressure should never be exceeded.

All load values are valid for ground slopes up to and including 20% (11°). When operating on slopes greater than 20%, please, contact the producer.

Load-pressure data for cyclic applications apply to low-torque transport operations at max. speeds of 10 km/h and for a max. distance of 800 meters before discharging the load and returning empty.

Tubeless tires – may be used with a tube.



	Tire load capacity (kg) at tire pressure (bar)									Speed (km/h)
	1.2	1.6	2.0	2.4	2.8	3.2	3.6	4.0	4.4	
		2 900	3 215	3 450	3 730	4 025	4 290	4 500		50
2 385	2 900	3 215	3 450	3 730	4 025	4 290	4 500			40
2 550	3 105	3 440	3 690	3 990	4 305	4 590	4 815			30
2 930	3 565	3 955	4 245	4 590	4 950	5 275	5 535			20
3 335	4 060	4 505	4 830	5 220	5 635	6 005	6 300		6 620	10
3 575	4 350	4 825	5 175	5 595	6 040	6 435	6 750		7 095	10 Cyclic
	2 360	2 590	2 760	3 025	3 265	3 450				50
1 930	2 360	2 590	2 760	3 025	3 265	3 450				40
2 070	2 525	2 775	2 955	3 235	3 490	3 690				30
2 375	2 905	3 190	3 395	3 720	4 015	4 225				20
2 705	3 305	3 630	3 865	4 235	4 570	4 830		5 135		10
2 900	3 545	3 890	4 140	4 535	4 895	5 175		5 505		10 Cyclic
	3 000	3 330	3 550							50
2 485	3 000	3 330	3 550							40
2 655	3 210	3 565	3 800							30
3 055	3 690	4 095	4 365							20
3 225	3 900	4 330	4 615	4 800						10
3 725	4 500	4 995	5 325	5 535						10 Cyclic
	3 450	3 750	4 000	4 375	4 750					65
2 800	3 450	3 750	4 000	4 375	4 750					50
2 940	3 620	3 940	4 200	4 595	5 000					40
3 070	3 780	4 120	4 380	4 790	5 200					30
3 220	3 965	4 315	4 600	5 030	5 465					20
3 920	4 830	5 250	5 600	6 125	6 650					10
4 200	5 175	5 625	6 000	6 565	7 125					10 Cyclic



HC 3000

LOAD CAPACITY	● ● ● ● ● ● ● ●
TRACTION	● ● ● ● ● ● ● ●
SOIL PROTECTION	● ● ● ● ● ● ● ●
HANDLING ON ROAD	● ● ● ● ● ● ● ●



HC 3000 R

LOAD CAPACITY	● ● ● ● ● ● ● ●
TRACTION	● ● ● ● ● ● ● ●
SOIL PROTECTION	● ● ● ● ● ● ● ●
HANDLING ON ROAD	● ● ● ● ● ● ● ●

HC 3000 – VF tire

Very High Flexion

Harvester tire for Cyclic Field Operation (CFO)



Less inflation pressure provides **excellent traction** efficiency.





Higher load capacity for higher haulage efficiency.



Larger footprint for **better ground protection** and **reduced soil compaction**.

Mitas VF 710/70 R 42 CFO HC 3000

Lower soil compaction for sustainable farming.

Standard	710/70 R 42 179A8	VF 710/70 R 42 CFO	800/70 R 38 181A8
Inflation pressure (bar)	3.8	2.8	3.0
Footprint (%)	100	136	127
		 + 36%	 + 27%

Inflation pressures and footprints at 13 300 kg load/tire at cyclic field conditions.



HC 3000

Technical data and load capacities

Tire size	Service description LI/SS	Rims * (permitted)	Section width (mm)	Overall diameter (mm)	Loaded static radius (mm)	Rolling circumference (mm)	Speed radius index	
VF 750/65 R 26 CFO	180 B	DW 27 DW 25 DW 28	777 757 787	1 623	680	4 680	775	
VF 1000/65 R 32 CFO#	200 A8	DW 36 DW 38	1 042 1 062	2 112	940	6 275	975	
VF 580/80 R 34 CFO	178 B	W 20 W 18 W 21	600 580 610	1 782	755	5 265	875	
VF 520/85 R 42 CFO	177 B	DW 18 DW 16	551 531	1 966	875	5 860	925	
VF 580/85 R 42 CFO	183 B	DW 18 DW 20 DW 21	585 605 615	2 040	920	6 100	975	
VF 710/70 R 42 CFO	190 B	DW 23 B DW 25 B	714 734	2 070	920	6 140	975	
VF 710/70 R 42 CFO	193 B	DW 23 B DW 25 B	715 735	2 083	920	6 140	975	

* Additional permitted rims may be available on request

Tread pattern HC 3000 R

For plowing with single driven tires in the furrow, a minimum inflation pressure of 0.8 bar is required.

For intensive road transport at 50/40/30 km/h the pressure must be increased by 0.4 bar. Maximum inflation pressure should never be exceeded.

All load values are valid for ground slopes up to and including 20% (11°). When operating on slopes greater than 20%, please, contact the producer.

Load-pressure data for cyclic applications apply to low-torque transport operations at max. speeds of 15 km/h and for a max. distance of 800 meters before discharging the load and returning empty.

By cyclic application (CFO) mean harvester's motion with full grain tank till its discharging.

CFO: Cyclic Field Operation

Tubeless tires – may be used with a tube.



HC 3000 R

HC 3000

	Tire load capacity (kg) at tire pressure (bar)									Speed (km/h)
	0.8	1.0	1.2	1.6	2.0	2.4	2.8	3.2	3.6	
	4 125	4 635	5 150	6 150	6 700	7 300	8 000			0-50 0-50 Dual 0-15 CFO 0-15 CFO Dual
	3 630	4 080	4 530	5 410	5 895	6 425	7 040			
	5 570	6 260	6 955	8 305	9 045	9 855	10 800			
	4 900	5 510	6 120	7 310	7 960	8 670	9 505			
				9 645	10 740	11 375	12 740			50 0-40 30 CFO 15 CFO
		8 000	9 000	10 600	11 800	12 500	14 000			
		8 880	9 990	11 765	13 100	13 875	15 540			
		10 640	11 970	14 100	15 695	16 625	18 620			
	3 750	4 250	4 800	5 800	6 300	6 900	7 500			0-50 0-50 Dual 0-15 CFO 0-15 CFO Dual
	3 300	3 740	4 225	5 105	5 545	6 070	6 600			
	5 065	5 740	6 480	7 830	8 505	9 315	10 125			
	4 455	5 050	5 700	6 890	7 485	8 195	8 910			
	3 650	4 135	4 625	5 800	6 300	6 700	7 300			0-50 0-50 Dual 0-15 CFO 0-15 CFO Dual
	3 210	3 640	4 070	5 105	5 545	5 895	6 425			
	4 930	5 585	6 245	7 830	8 505	9 045	9 855			
	4 340	4 915	5 495	6 890	7 485	7 960	8 670			
	4 375	4 910	5 450	6 700	7 500	8 000	8 750			0-50 0-50 Dual 0-15 CFO 0-15 CFO Dual
	3 850	4 320	4 795	5 895	6 600	7 040	7 700			
	5 905	6 630	7 360	9 045	10 125	10 800	11 815			
	5 195	5 835	6 475	7 960	8 910	9 505	10 395			
	5 000	5 600	6 300	7 750	8 500	9 000	10 000	10 600		0-50 0-50 Dual 0-15 CFO 0-15 CFO Dual
	4 400	4 930	5 545	6 820	7 480	7 920	8 800	9 330		
	6 750	7 560	8 505	10 465	11 475	12 150	13 500	14 310		
	5 940	6 655	7 485	9 210	10 100	10 690	11 880	12 595		
	5 000	5 600	6 300	7 750	8 500	9 000	10 000	10 600	11 500	0-50 0-50 Dual 0-15 CFO 0-15 CFO Dual
	4 400	4 930	5 545	6 820	7 480	7 920	8 800	9 330	10 120	
	6 750	7 560	8 505	10 465	11 475	12 150	13 500	14 310	15 525	
	5 940	6 655	7 485	9 210	10 100	10 690	11 880	12 595	13 660	



SFT CHO

LOAD CAPACITY	● ● ● ● ● ● ● ●
TRACTION	● ● ● ● ● ● ● ●
SOIL PROTECTION	● ● ● ● ● ● ● ●
HANDLING ON ROAD	● ● ● ● ● ● ● ●

CHO

Cyclic Harvesting Operation tire.
The most gentle ground handling
tire extending comfortably the
harvesting time frame



Harvester tire with **maximum cyclic axle load capacity**.



Extremely low inflation pressure and more maximum load capacity at the same time.



Larger footprint than standard harvester tires guarantees gentler ground handling and extends the harvesting time frame.



Due to its **compact, narrow construction** the tire fulfils all legal requirements (limited vehicle width).

Vehicle width decrease



Mobility increase

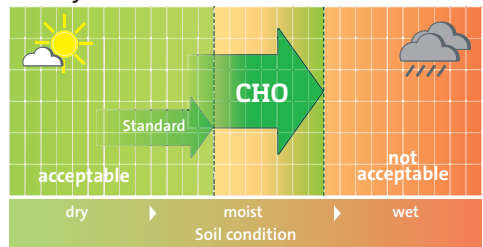

Harvesting time frame

Extension of time frame for harvesting by reducing inflation pressure.

Harvester CHO drive wheel

Technical data and load capacities

Tire size	Tread pattern	Service description LI/SS	Rims * (permitted)	Section width (mm)	Overall diameter (mm)	Loaded static radius (mm)	Rolling circumference (mm)	Speed radius index
680/85 R 32 CHO	AC 70 G	178 A8 (175 B)	DW 20 B DW 21 B DW 23 B	663 673 693	1 960	858	5 865	925
800/70 R 32 CHO	SFT	175 A8 (172 B)	DW 25 B DW 27 B	748 768	1 932	845	5 630	900
900/60 R 32 CHO	SFT	176 A8 (173 B)	DW 27 B DW 30 B	835 865	1 927	851	5 700	900
900/70 R 32 CHO	SFT	182 A8 (179 B)	DW 27 B DW 30 B	881 911	2 061	904	6 075	975
900/70 R 32 CHO	SFT	188 A8 (185 B)	DW 27 B DW 30 B	885 915	2 058	904	6 075	975
1050/50 R 32 CHO	SFT	184 A8 (181 B)	36.00 VA 36.00 / 1.7 DW 36 B	1 035 1 035 1 035	1 901	855	5 640	875
1250/50 R 32 CHO	SFT	194 A8 (191 B)	44" 40"	1 200 1 160	2 030	890	6 000	975
680/80 R 38 CHO	SFT	179 D (182 A8)	DW 21 B DW 20 B DW 23 B	650 640 670	2 053	895	6 070	975



	Tire load capacity (kg) at tire pressure (bar)									Speed (km/h)
	0.8	1.0	1.2	1.4	1.6	2.0	2.4	2.8	3.2	
		3 865	4 230	4 635	5 000	5 515	6 000	6 435	6 900	50
	3 915	4 245	4 645	5 090	5 450	6 060	6 500	7 070	7 500	40
	4 190	4 540	4 970	5 445	5 830	6 485	6 955	7 565	8 025	30
	4 345	4 710	5 155	5 650	6 050	6 725	7 215	7 850	8 235	25
	4 815	5 220	5 715	6 260	6 705	7 450	7 995	8 695	9 225	20
	7 045	7 640	8 365	9 165	9 810	10 905	11 700	12 725	13 500	10 CHO
		4 180	4 575	5 010	5 450	5 965	6 300			50
	4 235	4 590	5 025	5 505	6 000	6 555	6 900			40
	4 530	4 915	5 380	5 895	6 420	7 015	7 385			30
	4 700	5 095	5 580	6 115	6 600	7 275	7 660			25
	5 210	5 650	6 180	6 775	7 380	8 060	8 485			20
	7 625	8 265	9 045	9 915	10 750	11 800	12 500			10 CHO
		4 250	4 650	5 020	5 300	5 950	6 500			50
	4 315	4 670	5 110	5 515	5 800	6 535	7 100			40
	4 615	5 000	5 465	5 900	6 205	6 995	7 595			30
	4 790	5 185	5 670	6 120	6 440	7 255	7 880			25
	5 305	5 745	6 285	6 785	7 135	8 040	8 735			20
	7 765	8 410	9 195	9 925	10 440	11 765	12 780			10 CHO
	4 660	5 055	5 530	6 060	6 700	7 215	7 750			50
	5 120	5 555	6 080	6 660	7 300	7 925	8 500			40
	5 480	5 945	6 505	7 125	7 810	8 480	9 095			30
	5 685	6 165	6 750	7 395	8 105	8 800	9 435			25
	6 300	6 830	7 475	8 195	8 980	9 750	10 455			20
	9 220	9 995	10 940	11 990	13 140	14 270	15 300			10 CHO
		5 055	5 530	6 060	6 700	7 215	7 750	8 415	9 250	50
	5 120	5 555	6 080	6 660	7 300	7 925	8 500	9 250	10 000	40
	5 480	5 945	6 505	7 125	7 810	8 480	9 095	9 895	10 700	30
	5 685	6 165	6 750	7 395	8 105	8 800	9 435	10 265	11 100	25
	6 300	6 830	7 475	8 195	8 980	9 750	10 455	11 375	12 300	20
	9 220	9 995	10 940	11 990	13 140	14 270	15 300	16 650	18 000	10 CHO
		4 625	5 000	5 300	5 800	6 300	6 900	7 500	8 250	50
	4 655	5 045	5 515	5 800	6 300	6 900	7 500	8 250	9 000	40
	4 985	5 400	5 900	6 210	6 740	7 385	8 025	8 830	9 630	30
	5 170	5 600	6 120	6 440	6 995	7 660	8 325	9 160	9 990	25
	5 730	6 205	6 785	7 135	7 750	8 485	9 225	10 150	11 070	20
	8 380	9 080	9 925	10 440	11 340	12 420	13 500	14 850	16 200	10 CHO
		5 655	6 265	7 010	7 750	8 500	9 100	10 040	10 900	50
	5 515	6 210	6 885	7 700	8 500	9 340	10 000	11 035	11 800	40
	5 905	6 645	7 365	8 240	9 095	9 995	10 700	11 805	12 625	30
	6 125	6 895	7 640	8 545	9 435	10 365	11 100	12 250	13 100	25
	6 785	7 640	8 470	9 470	10 455	11 490	12 300	13 575	14 515	20
	9 925	11 180	12 395	13 860	15 300	16 810	18 000	19 865	21 240	10 CHO
		4 070	4 580	5 090	5 600	6 125	6 500	7 175	7 750	65
	3 740	4 275	4 810	5 345	5 880	6 430	6 825	7 535	8 140	50
	3 900	4 460	5 015	5 575	6 150	6 705	7 100	7 855	8 500	40
	4 100	4 685	5 270	5 855	6 440	7 045	7 475	8 350	8 915	30
	4 220	4 825	5 430	6 030	6 635	7 260	7 705	8 505	9 185	25
	4 380	5 005	5 635	6 260	6 890	7 535	7 995	8 825	9 535	20
	6 415	7 330	8 245	9 160	10 080	11 025	11 700	12 915	13 950	10 CHO

Harvester CHO drive wheel

Technical data and load capacities

Tire size	Tread pattern	Service description LI/SS	Rims * (permitted)	Section width (mm)	Overall diameter (mm)	Loaded static radius (mm)	Rolling circumference (mm)	Speed radius index
800/70 R 38 CHO	SFT	178 D (181 A8)	DW 25 B DW 27 B	766 786	2 042	916	6 090	975
800/70 R 38 CHO	SFT	181 D (184 A8)	DW 25 B DW 27 B	766 786	2 042	916	6 090	975
900/60 R 38 CHO	SFT	181 D (184 A8)	DW 27 B DW 30 B	860 890	2 055	918	6 115	975
680/80 R 42 CHO	SFT	180 D (183 A8)	DW 21 B DW 23 B DW 20 B	660 680 650	2 145	983	6 500	1 025
800/70 R 42 CHO	SFT	182 D (185 A8)	DW 25 B DW 27 B	766 786	2 160	945	6 320	1 025
900/60 R 42 CHO	SFT	183 D (186 A8)	DW 27 B DW 28 B DW 30 B	860 870 890	2 135	965	6 400	1 025

* Additional permitted rims may be available on request

30 km/h (up to 40 km/h) load values also apply for low-speed high-torque field work.

For plowing with single driven tires in the furrow, a minimum inflation pressure of 0.8 bar is required.

For intensive road transport at 65/50/40/30 km/h the pressure must be increased by 0.4 bar. Maximum inflation pressure should never be exceeded.

All load values are valid for ground slopes up to and including 20% (11°). When operating on slopes greater than 20%, please, contact the producer.

Load-pressure data for cyclic applications apply to low-torque transport operations at max. speeds of 10 km/h and for a max. distance of 800 meters before discharging the load and returning empty.



	Tire load capacity (kg) at tire pressure (bar)									Speed (km/h)	
	0.8	1.0	1.2	1.4	1.6	2.0	2.4	2.8	3.2		
		4 705	5 300	5 900	6 500	7 100	7 500				65
	4 330	4 940	5 565	6 195	6 825	7 455	7 875				50
	4 515	5 150	5 800	6 450	7 100	7 750	8 250				40
	4 745	5 410	6 095	6 785	7 475	8 165	8 625				30
	4 890	5 575	6 280	6 990	7 705	8 415	8 890				25
	5 075	5 785	6 520	7 255	7 995	8 735	9 225				20
	7 425	8 470	9 540	10 620	11 700	12 780	13 500				10 CHO
		4 705	5 300	5 900	6 500	7 100	7 500	8 250			65
	4 330	4 940	5 565	6 195	6 825	7 455	7 875	8 665			50
	4 515	5 150	5 800	6 450	7 100	7 750	8 250	9 000			40
	4 745	5 410	6 095	6 785	7 475	8 165	8 625	9 490			30
	4 890	5 575	6 280	6 990	7 705	8 415	8 890	9 775			25
	5 075	5 785	6 520	7 255	7 995	8 735	9 225	10 150			20
	7 425	8 470	9 540	10 620	11 700	12 780	13 500	14 850			10 CHO
		4 875	5 325	5 825	6 300	6 985	7 500	8 250			65
		5 120	5 590	6 115	6 615	7 335	7 875	8 665			50
	4 805	5 340	5 835	6 380	6 900	7 650	8 250	9 000			40
	5 000	5 605	6 125	6 700	7 245	8 035	8 625	9 490			30
	5 200	5 780	6 315	6 905	7 465	8 280	8 890	9 775			25
	5 350	5 995	6 550	7 165	7 750	8 590	9 225	10 150			20
	7 825	8 775	9 585	10 485	11 340	12 575	13 500	14 850			10 CHO
		4 535	4 920	5 360	5 800	6 415	6 900	7 490	8 000		65
	4 350	4 755	5 165	5 625	6 090	6 735	7 245	7 865	8 400		50
	4 540	4 960	5 385	5 865	6 350	7 025	7 555	8 200	8 750		40
	4 765	5 210	5 660	6 165	6 670	7 375	7 935	8 615	9 200		30
	4 915	5 370	5 830	6 350	6 875	7 600	8 175	8 875	9 480		25
	5 100	5 575	6 050	6 595	7 135	7 890	8 485	9 215	9 840		20
	7 465	8 160	8 860	9 650	10 440	11 550	12 420	13 480	14 400		10 CHO
		4 865	5 470	6 080	6 700	7 310	7 750	8 500			65
	4 470	5 110	5 745	6 385	7 035	7 675	8 140	8 925			50
	4 660	5 325	5 990	6 660	7 335	8 005	8 485	9 250			40
	4 895	5 595	6 290	6 990	7 705	8 405	8 915	9 775			30
	5 040	5 765	6 480	7 205	7 940	8 660	9 185	10 075			25
	5 230	5 985	6 730	7 480	8 240	8 990	9 535	10 455			20
	7 660	8 755	9 845	10 945	12 060	13 160	13 950	15 300			10 CHO
		4 875	5 400	6 005	6 700	7 330	8 000	8 750			65
	4 545	5 120	5 670	6 305	7 035	7 695	8 400	9 190			50
	4 740	5 340	5 915	6 575	7 335	8 025	8 760	9 500			40
	4 980	5 605	6 210	6 905	7 705	8 430	9 200	10 065			30
	5 130	5 775	6 400	7 115	7 940	8 685	9 480	10 370			25
	5 325	5 995	6 640	7 385	8 240	9 015	9 840	10 765			20
	7 795	8 775	9 725	10 805	12 060	13 195	14 400	15 750			10 CHO

By cyclic application (CHO) mean harvester's motion with full grain tank till its discharging.

CHO: Cyclic Harvesting Operation

Tubeless tires – may be used with a tube.



SFT

LOAD CAPACITY	● ● ● ● ● ●
TRACTION	● ● ● ● ● ●
SOIL PROTECTION	● ● ● ● ● ●
HANDLING ON ROAD	● ● ● ●



AC 70H

LOAD CAPACITY	● ● ● ● ● ●
TRACTION	● ● ● ● ● ●
SOIL PROTECTION	● ● ● ● ●
HANDLING ON ROAD	● ● ● ●



AC 70N

LOAD CAPACITY	● ● ● ● ● ●
TRACTION	● ● ● ● ● ●
SOIL PROTECTION	● ● ● ● ●
HANDLING ON ROAD	● ● ● ●

Harvester drive tires: AC 70 H/G/N and SFT – Super Flexion Tire

Innovative tires for gentle ground handling with harvesters



High load capacities and low inflation pressures.



Minimized load placed on soil structure, thanks to the wide and even distribution of ground pressure.



Low vibration and smooth on-road ride when moving between fields.



Very productive and cost-efficient thanks to performance in the field and in transport.



Harvester drive wheel

Technical data and load capacities

Tire size	Tread pattern	Service description LI/SS	Rims * (permitted)	Section width (mm)	Overall diameter (mm)	Loaded static radius (mm)	Rolling circumference (mm)	Speed radius index
1000/50 R 25	SFT	178 A8 (172 D)	36.0 TH 36.0 VA	1 020 1 020	1 655	740	4 930	775
620/75 R 26	SFT	166 A8 (166 B)	DW 20 B	625	1 590	689	4 660	750
620/75 R 30	SFT	166 D (169 A8)	W 20 B W 18 L W 21 B	635 615 645	1 700	740	4 980	800
650/75 R 32	AC 70 H	167 A8 (164 B)	DW 20 B DW 21 B	650 660	1 795	790	5 255	850
650/75 R 32	AC 75 G	167 A8 (164 B)	DW 20 B DW 21 B	635 645	1 798	782	5 245	850
650/75 R 32	AC 70 G	172 A8 (169 B)	DW 20 B DW 21 B	650 660	1 795	790	5 255	850
IF 650/75 R 32 CFO	AC 75 G	176 A8	DW 23 B DW 21 B DW 20 B	660 640 630	1 770	782	5 245	850



SFT

AC70H

AC70N

Tire load capacity (kg) at tire pressure (bar)												Speed (km/h)
0.6	0.8	1.0	1.2	1.4	1.6	2.0	2.4	2.8	3.2	4.0		
		3 470	3 905	4 355	4 790	5 355	5 735	6 300				65
	3 430	3 855	4 340	4 835	5 320	5 950	6 370	7 000				50
	3 830	4 250	4 780	5 270	5 800	6 445	6 900	7 500				40
	4 025	4 460	5 020	5 540	6 095	6 765	7 245	7 935				30
	4 145	4 600	5 175	5 710	6 280	6 970	7 465	8 175				25
	4 305	4 770	5 370	5 925	6 520	7 235	7 750	8 485				20
	4 550	5 045	5 675	6 265	6 890	7 650	8 190	8 970				10
	5 595	6 205	6 980	7 705	8 475	9 410	10 075	11 035				10 Cyclic
		2 835	3 190	3 545	3 875	4 280	4 500	4 995	5 300			50
	2 480	2 835	3 190	3 545	3 875	4 280	4 500	4 995	5 300			40
	2 655	3 035	3 415	3 795	4 145	4 580	4 815	5 345	5 670			30
	2 755	3 150	3 540	3 935	4 300	4 750	4 995	5 540	5 885			25
	3 050	3 490	3 925	4 360	4 765	5 265	5 535	6 140	6 520			20
	3 225	4 535	4 150	5 670	5 040	5 565	5 850	6 490	6 890	7 570		10
	3 970	5 580	5 105	6 975	6 200	6 845	7 200	7 990	8 480	9 320		10 Cyclic
		3 005	3 380	3 755	4 125	4 555	4 875	5 300				65
	2 465	2 760	3 155	3 550	3 940	4 330	4 780	5 120	5 565			50
	2 880	3 290	3 700	4 110	4 515	4 985	5 300	5 800				40
	2 590	3 025	3 455	3 885	4 315	4 745	5 235	5 605	6 205			30
	2 665	3 115	3 560	4 005	4 450	4 890	5 395	5 775	6 440			25
	2 930	3 415	3 905	4 395	4 880	5 365	5 920	6 340	7 540	8 700		10
	3 605	4 205	4 805	5 405	6 005	6 600	7 285	7 800	9 280	9 860		10 Cyclic
		3 200	3 500	3 835	4 160	4 565	5 000					50
	3 125	3 245	3 515	3 850	4 215	4 500	5 020	5 450				40
	3 245	3 470	3 760	4 120	4 510	4 895	5 370	5 835				30
	3 245	3 600	3 900	4 270	4 680	5 075	5 570	6 050				25
	3 595	3 990	4 325	4 735	5 185	5 625	6 170	6 705		(3.1 bar)		20
	3 800	4 215	4 570	5 005	5 480	5 945	6 525	7 085	7 610	8 000		10
	4 675	5 190	5 625	6 155	6 745	7 315	8 030	8 725	9 370	9 845		10 Cyclic
		3 200	3 500	3 835	4 160	4 565	5 000					50
	3 125	3 245	3 515	3 850	4 215	4 500	5 020	5 450				40
	3 245	3 470	3 760	4 120	4 510	4 895	5 370	5 835				30
	3 245	3 600	3 900	4 270	4 680	5 075	5 570	6 050				25
	3 595	3 990	4 325	4 735	5 185	5 625	6 170	6 705		(3.1 bar)		20
	3 800	4 215	4 570	5 005	5 480	5 945	6 525	7 085	7 610	8 000		10
	4 675	5 190	5 625	6 155	6 745	7 315	8 030	8 725	9 370	9 845		10 Cyclic
		3 200	3 500	3 835	4 160	4 565	5 000	5 330	5 800			50
	3 125	3 245	3 515	3 850	4 215	4 500	5 020	5 450	6 300			40
	3 245	3 470	3 760	4 120	4 510	4 895	5 370	5 835	6 265	6 740		30
	3 245	3 600	3 900	4 270	4 680	5 075	5 570	6 050	6 500	6 995		25
	3 595	3 990	4 325	4 735	5 185	5 625	6 170	6 705	7 200	7 750		20
	3 800	4 215	4 570	5 005	5 480	5 945	6 525	7 085	7 610	8 190	9 235	10
	4 675	5 190	5 625	6 155	6 745	7 315	8 030	8 725	9 370	10 080	11 365	10 Cyclic
		4 000	4 500	5 000	5 450	6 000	6 500	7 100				40
	2 705	3 080	3 520	3 960	4 400	4 795	5 280	5 720	6 250			40 Dual
			6 160	6 975	7 700	8 450	9 300	10 075	11 005			15 CFO
	4 295	4 775	5 440	6 140	6 800	7 435	8 185	8 865	9 685			15 CFO Dual

Harvester drive wheel

Technical data and load capacities

Tire size	Tread pattern	Service description LI/SS	Rims * (permitted)	Section width (mm)	Overall diameter (mm)	Loaded static radius (mm)	Rolling circumference (mm)	Speed radius index
680/85 R 32	AC 70 G	178 A8 (175 B)	DW 20 B DW 21 B DW 23 B	662 672 692	1 960	852	5 865	925
800/65 R 32	AC 70 H	172 A8 (169 B)	DW 25 B DW 27 B	795 815	1 820	830	5 430	875
800/65 R 32	AC 70 N	178 A8 (175 B)	DW 25 B DW 27 B	743 763	1 855	837	5 500	875
800/70 R 32	SFT	175 A8 (172 B)	DW 25 B DW 27 B	762 784	1 932	845	5 630	900
900/60 R 32	SFT	176 A8 (173 B)	DW 27 B DW 30 B	857 890	1 905	850	5 700	900
900/60 R 32	SFT	181 A8 (178 B)	DW 27 B DW 30 B	857 890	1 905	850	5 700	900



SFT

AC70H

Tire load capacity (kg) at tire pressure (bar)												Speed (km/h)
0.6	0.8	1.0	1.2	1.4	1.6	2.0	2.4	2.8	3.2	4.0		
		3 865	4 230	4 635	5 025	5 515	6 000	6 435	6 900		50	
	3 915	4 245	4 645	5 090	5 520	6 060	6 500	7 070	7 500		40	
3 775	4 190	4 540	4 975	5 445	5 910	6 485	6 955	7 565	8 025		30	
3 915	4 345	4 710	5 155	5 650	6 130	6 725	7 215	7 850	8 325		25	
4 340	4 815	5 220	5 715	6 260	6 790	7 450	7 995	8 695	9 225		20	
4 585	5 090	5 520	6 040	6 620	7 175	7 875	8 450	9 190	9 750	11 150	10	
5 645	6 265	6 790	7 435	8 145	8 835	9 695	10 400	11 310	11 995	13 720	10 Cyclic	
		3 900	4 270	4 610	5 000	5 310	5 800				50	
	3 950	4 285	4 690	5 065	5 450	5 835	6 300				40	
3 810	4 230	4 585	5 020	5 420	5 830	6 245	6 745				30	
3 955	4 385	4 755	5 205	5 625	6 050	6 475	6 995				25	
4 380	4 860	5 270	5 770	6 230	6 705	7 175	7 750		(3.1 bar)		20	
4 630	5 140	5 570	6 100	6 585	7 085	7 585	8 190	8 960	9 400		10	
5 700	6 325	6 855	7 505	8 105	8 720	9 335	10 085	11 025	11 570		10 Cyclic	
		3 900	4 270	4 610	5 000	5 310	5 800	6 270	6 900		50	
	3 950	4 285	4 690	5 065	5 450	5 835	6 300	6 890	7 500		40	
3 810	4 230	4 585	5 020	5 420	5 830	6 245	6 745	7 375	8 025		30	
3 955	4 385	4 755	5 205	5 625	6 050	6 475	6 995	7 650	8 325		25	
4 380	4 860	5 270	5 770	6 230	6 705	7 175	7 750	8 475	9 225		20	
4 630	5 140	5 570	6 100	6 585	7 085	7 585	8 190	8 960	9 750	10 820	10	
5 700	6 325	6 855	7 505	8 105	8 720	9 335	10 085	11 025	12 000	13 320	10 Cyclic	
		4 180	4 575	5 010	5 460	5 965	6 300				50	
	4 235	4 590	5 025	5 505	6 000	6 555	6 900				40	
4 085	4 530	4 915	5 380	5 895	6 420	7 015	7 385				30	
4 235	4 700	5 095	5 580	6 115	6 600	7 275	7 660				25	
4 695	5 210	5 650	6 180	6 775	7 380	8 060	8 485				20	
4 960	5 505	5 970	6 535	7 160	7 800	8 520	8 970	10 350			10	
6 105	6 775	7 345	8 040	8 810	9 600	10 485	11 040	11 730			10 Cyclic	
		4 250	4 650	5 020	5 460	5 950	6 500				50	
	4 315	4 670	5 110	5 515	6 000	6 535	7 100				40	
4 165	4 615	5 000	5 465	5 900	6 420	6 995	7 595				30	
4 320	4 790	5 185	5 670	6 120	6 660	7 255	7 880				25	
4 790	5 305	5 745	6 285	6 785	7 380	8 040	8 735				20	
5 060	5 610	6 070	6 640	7 170	7 800	8 495	9 230	10 650			10	
6 230	6 905	7 475	8 175	8 825	9 600	10 460	11 360	12 070			10 Cyclic	
		4 250	4 650	5 020	5 460	5 950	6 500	7 025	7 500		50	
	4 315	4 670	5 110	5 515	6 000	6 535	7 100	7 720	8 250		40	
4 165	4 615	5 000	5 465	5 900	6 420	6 995	7 595	8 260	8 830		30	
4 320	4 790	5 185	5 670	6 120	6 660	7 255	7 880	8 570	9 160		25	
4 790	5 305	5 745	6 285	6 785	7 380	8 040	8 735	9 495	10 150		20	
5 060	5 610	6 070	6 640	7 170	7 800	8 495	9 230	10 810	11 550	13 055	10	
6 230	6 905	7 475	8 175	8 825	9 600	10 460	11 360	12 350	13 200	14 920	10 Cyclic	

Harvester drive wheel

Technical data and load capacities

Tire size	Tread pattern	Service description LI/SS	Rims * (permitted)	Section width (mm)	Overall diameter (mm)	Loaded static radius (mm)	Rolling circumference (mm)	Speed radius index
900/70 R 32	SFT	188 A8 (185 B)	DW 27 B DW 30 B	895 925	2 050	896	6 050	975
1050/50 R 32	SFT	178 A8 (178 B)	36.00 VA	1 015	1 890	845	5 640	875
1250/50 R 32	SFT	188 A8 (185 B)	44" 40"	1 220 1 180	2 020	890	6 000	975
1250/50 R 32	SFT	194 A8 (191 B)	44" 40"	1 220 1 180	2 020	890	6 000	975
900/60 R 38	SFT	178 D (181 A8)	DW 27 B DW 30 B	870 900	2 060	918	6 115	975
580/85 R 42	SFT	163 D (166 A8)	W 18 L DW 20 B DW 21 B	567 587 597	2 045	920	6 100	975



	Tire load capacity (kg) at tire pressure (bar)											Speed (km/h)
	0.6	0.8	1.0	1.2	1.4	1.6	2.0	2.4	2.8	3.2	4.0	
		4 660	5 055	5 530	6 060	6 700	7 215	7 750	8 415	9 250		50
4 615	4 660	5 055	5 530	6 060	6 700	7 215	7 750	8 415	9 250		40	
4 940	5 120	5 555	6 080	6 660	7 300	7 925	8 500	9 250	10 000		30	
5 125	5 480	5 945	6 505	7 125	7 810	8 480	9 095	9 895	10 700		25	
5 675	5 685	6 165	6 750	7 395	8 105	8 800	9 435	10 265	11 100		20	
6 000	6 300	6 830	7 475	8 195	8 980	9 750	10 455	11 375	12 300		10	
7 385	6 660	7 220	7 905	8 660	9 490	10 305	11 050	12 025	13 000	14 585	10	
	8 195	8 885	9 725	10 655	11 680	12 685	13 600	14 800	16 000	17 950	10	
		5 045	5 515	5 955	6 500	7 055	7 500				50	
4 495	4 655	5 045	5 515	5 955	6 500	7 055	7 500				40	
4 665	4 985	5 395	5 900	6 370	6 955	7 550	8 025				30	
5 170	5 170	5 595	6 120	6 610	7 215	7 830	8 325				25	
5 465	5 730	6 200	6 785	7 320	7 995	8 680	9 225				20	
6 725	6 055	6 555	7 170	7 740	8 450	9 175	9 750	11 250			10	
	7 450	8 070	8 825	9 525	10 400	11 290	12 000	12 750			10	
		5 655	6 265	6 960	7 750	8 500	9 250				50	
4 730	5 020	5 655	6 265	6 960	7 750	8 500	9 250				40	
5 060	5 515	6 210	6 885	7 650	8 500	9 340	10 000				30	
5 250	5 905	6 645	7 265	8 185	9 095	9 995	10 700				25	
5 815	6 125	6 895	7 640	8 490	9 435	10 370	11 100				20	
6 620	6 785	7 640	8 470	9 410	10 455	11 490	12 300				10	
7 565	7 725	8 695	9 640	10 710	11 900	13 075	14 000	15 445			10	
	8 825	9 940	11 015	12 240	13 600	14 945	16 000	17 655			10	
		5 655	6 265	6 960	7 750	8 500	9 250	10 040	10 900		50	
4 730	5 020	5 655	6 265	6 960	7 750	8 500	9 250	10 040	10 900		40	
5 060	5 515	6 210	6 885	7 650	8 500	9 340	10 000	11 035	11 800		30	
5 250	5 905	6 645	7 265	8 185	9 095	9 995	10 700	11 805	12 625		25	
5 815	6 125	6 895	7 640	8 490	9 435	10 370	11 100	12 245	13 100		20	
6 620	6 785	7 640	8 470	9 410	10 455	11 490	12 300	13 570	14 515		10	
7 565	7 725	8 695	9 640	10 710	11 900	13 075	14 000	15 445	16 520		10	
	8 825	9 940	11 015	12 240	13 600	14 945	16 000	17 655	18 880		10	
		4 875	5 325	5 825	6 300	6 985	7 500				65	
4 235	4 610	5 120	5 595	6 115	6 615	7 335	7 875				50	
4 450	4 805	5 340	5 835	6 375	6 900	7 650	8 250				40	
4 585	5 050	5 605	6 125	6 695	7 245	8 035	8 625				30	
4 755	5 200	5 780	6 315	6 900	7 465	8 280	8 890				25	
5 415	5 400	5 995	6 555	7 165	7 750	8 590	9 225				20	
6 190	6 145	6 825	7 460	8 155	8 820	9 780	10 500	11 250			10	
	7 025	7 800	8 525	9 315	10 080	11 175	12 000	12 750			10	
		3 605	3 945	4 405	4 875						65	
3 125	3 405	3 785	4 140	4 630	5 120						50	
3 285	3 550	3 950	4 320	4 825	5 300						40	
3 375	3 730	4 145	4 535	5 070	5 605						30	
3 500	3 835	4 270	4 675	5 220	5 775						25	
3 995	3 975	4 435	4 850	5 415	5 995						20	
4 570	4 540	5 050	5 520	6 170	6 825	7 260					10	
	5 190	5 770	6 310	7 050	7 800	8 290					10	

Harvester drive wheel

Technical data and load capacities

Tire size	Tread pattern	Service description LI/SS	Rims * (permitted)	Section width (mm)	Overall diameter (mm)	Loaded static radius (mm)	Rolling circumference (mm)	Speed radius index
580/85 R 42	SFT	168 D (171 A8)	W 18 L DW 20 B DW 21 B	590 610 620	2 050	920	6 100	975
680/80 R 42	SFT	180 D (183 A8)	DW 21 B DW 23 B DW 20 B	660 680 650	2 160	965	6 400	1 025
IF 900/60 R 42 CFO	SFT	192 A8	DW 27 B DW 28 B DW 30 B	860 870 890	2 135	965	6 400	1 025

* Additional permitted rims may be available on request

Load values for 0.6 bar are for calculating dual and triple load values only.

30 km/h (up to 40 km/h) load values also apply for low-speed high-torque field work.

For plowing with single driven tires in the furrow, a minimum inflation pressure of 0.8 bar is required.

For intensive road transport at 65/50/40/30 km/h the pressure must be increased by 0.4 bar. Maximum inflation pressure should never be exceeded.

All load values are valid for ground slopes up to and including 20% (11°). When operating on slopes greater than 20%, please, contact the producer.

Load-pressure data for cyclic applications apply to low-torque transport operations at max. speeds of 10 km/h and for a max. distance of 800 meters before discharging the load and returning empty.

By cyclic application is means harvester's motion with full grain tank till its discharging.

Tubeless tires – may be used with a tube.

SFT



	Tire load capacity (kg) at tire pressure (bar)											Speed (km/h)	
	0.6	0.8	1.0	1.2	1.4	1.6	2.0	2.4	2.8	3.2	4.0		
			3 605	3 945	4 405	4 875	5 275	5 600					65
		3 405	3 785	4 140	4 630	5 120	5 540	5 880					50
3 125	3 550	3 950	4 320	4 825	5 300	5 775	6 250	6 150					40
3 285	3 730	4 145	4 535	5 070	5 605	6 065	6 440						30
3 375	3 835	4 270	4 675	5 220	5 775	6 250	6 635						25
3 500	3 975	4 435	4 850	5 415	5 995	6 485	6 885						20
3 995	4 540	5 050	5 520	6 170	6 825	7 385	7 840						10
4 570	5 190	5 770	6 310	7 050	7 800	8 440	8 960						10 Cyclic
			4 495	4 920	5 390	5 800	6 415	6 900	7 490	8 000			65
3 920	4 350	4 720	5 165	5 660	6 090	6 735	7 245	7 865	8 400				50
4 090	4 540	4 920	5 385	5 900	6 300	7 025	7 500	8 200	8 750				40
4 295	4 765	5 170	5 660	6 200	6 670	7 375	7 935	8 615	9 200				30
4 425	4 910	5 325	5 830	6 385	6 875	7 600	8 175	8 875	9 480				25
4 595	5 100	5 530	6 055	6 630	7 135	7 895	8 485	9 210	9 840				20
4 855	5 390	5 845	6 400	7 010	7 540	8 345	8 970	9 735	10 400	11 810			10
5 980	6 635	7 195	7 875	8 625	9 280	10 270	11 040	11 980	12 800	14 535			10 Cyclic
		5 065	5 800	6 535	7 270	8 000	8 750	9 500	10 300	11 200			40
		5 265	6 030	6 795	7 560	8 320	9 100	9 880	10 710	11 650			30
		5 475	6 265	7 055	7 845	8 640	9 450	10 260	11 125	12 095			20
		5 825	6 670	7 460	8 250	9 200	10 065	10 925	11 845	12 880			10
		6 585	7 540	8 385	9 230	10 400	11 375	12 350	13 390	14 560			30 CFO
		7 855	8 990	9 945	10 900	12 400	13 565	14 725	15 965	17 360			15 CFO

Harvester radial tires



SFT IMP

LOAD CAPACITY	● ● ● ● ● ●
TRACTION	● ● ● ● ● ●
SOIL PROTECTION	● ● ● ● ● ●
HANDLING ON ROAD	● ● ● ● ●



SFT N IMP

LOAD CAPACITY	● ● ● ● ● ●
TRACTION	● ● ● ● ● ●
SOIL PROTECTION	● ● ● ● ● ●
HANDLING ON ROAD	● ● ● ● ●



AC 65 IMP

LOAD CAPACITY	● ● ● ● ● ●
TRACTION	● ● ● ● ● ●
SOIL PROTECTION	● ● ● ● ● ●
HANDLING ON ROAD	● ● ● ● ●



AC 70 G IMP

LOAD CAPACITY	● ● ● ● ● ●
TRACTION	● ● ● ● ● ●
SOIL PROTECTION	● ● ● ● ● ●
HANDLING ON ROAD	● ● ● ● ●

SFT IMP, SFT N IMP, AC 65 IMP & AC 70 G IMP

Tremendous flexion and load capacity make these tires a great fit for the steering axle of a harvester



Outstanding traction thanks to very large ground contact patch.



High load capacity and optimal ground pressure distribution reduces soil compaction.



Long tire life through optimized tread pattern design and high resistance to damage.



Suitable also for free-rolling field applications.



Harvester steering wheel

Technical data and load capacities

Tire size	Tread pattern	Rims * (permitted)	Section width (mm)	Overall diameter (mm)	Loaded static radius (mm)	Rolling circumference (mm)	Speed radius index
460/70 R 24 IMP 163 / 151 A8	AC 70 G IMP	W 15 L W 14 L W 16 L	455 445 465	1 236	528 ⊕→ 552 ⊕	3 620 ⊕→ 3 690 ⊕	600
500/70 R 24 IMP 167 / 155 A8	AC 70 G IMP	DW 16 L W 16 L DW 15 L W 15 L	496 496 486 486	1 313	573 ⊕→ 591 ⊕	3 908 ⊕→ 3 919 ⊕	625
500/85 R 24 IMP 171 / 158 A8	SFT IMP	DW 16 L W 16 L DW 15 L W 15 L	528 528 518 518	1 458	621 ⊕→ 650 ⊕	4 237 ⊕→ 4 325 ⊕	700
500/85 R 24 IMP 182 / 161 A8	SFT IMP	DW 16 L W 16 L DW 15 L W 15 L	527 527 517 517	1 461	615 ⊕→ 645 ⊕	4 225 ⊕→ 4 315 ⊕	700
620/55 R 26 IMP 168 / 150 A8	SFT IMP	DW 20 B DW 18 L W 18 L DW 21 B	590 570 570 600	1 332	600 ⊕→ 618 ⊕	3 995 ⊕→ 4 050 ⊕	650
500/80 R 28 IMP 176 / 164 A8	SFT IMP	DW 16 L W 16 L DW 15 L W 15 L	517 517 507 507	1 495	635 ⊕→ 663 ⊕	4 355 ⊕→ 4 440 ⊕	725

AC 70 G IMP



SFT IMP



	Service description LI/SS	Tire load capacity (kg) at tire pressure (bar)									Speed (km/h)
		0.8	1.2	1.6	2.0	2.4	2.8	3.2	3.6	4.0	
163 A8 ⇄	1900	2430	3000	3450	4000	4375	4875			40	
	2130	2720	3360	3865	4480	4900	5460			30	
	2395	3060	3780	4345	5040	5515	6145			20	
	2660	3400	4200	4830	5600	6125	6825			10	
151 A8 ⇄	1360	1750	2180	2500	2800	3150	3450			40	
	1525	1960	2440	2800	3135	3530	3865			30	
	1715	2205	2745	3150	3530	3970	4345			20	
	1905	2450	3050	3500	3920	4410	4830			10	
167 A8 ⇄	2300	2900	3550	4125	4750	5450				40	
	2575	3250	3975	4620	5320	6105				30	
	2900	3655	4475	5200	5985	6865				20	
	3220	4060	4970	5775	6650	7630				10	
155 A8 ⇄	1685	2165	2645	3065	3480	3875				40	
	1885	2425	2960	3430	3900	4340				30	
	2120	2725	3330	3860	4385	4885				20	
	2355	3030	3700	4290	4875	5425				10	
171 A8 ⇄	2600	3340	4085	4730	5375	6150				40	
	2910	3740	4575	5295	6020	6890				30	
	3275	4210	5145	5960	6770	7750				20	
	3635	4675	5715	6620	7525	8610				10	
158 A8 ⇄	1795	2310	2820	3270	3715	4250				40	
	2010	2585	3160	3660	4160	4760				30	
	2260	2910	3555	4115	4680	5355				20	
	2515	3230	3950	4575	5200	5950				10	
182 A8 ⇄	2725	3550	4250	5000	5800	6500	6900	7750	8500	40	
	3050	3975	4760	5600	6495	7280	7730	8680	9520	30	
	3435	4475	5355	6300	7310	8190	8695	9765	10710	20	
	3815	4970	5950	7000	8120	9100	9660	10850	11900	10	
161 A8 ⇄	1900	2430	3000	3350	3550	3875	4125	4375	4625	40	
	2130	2720	3360	3750	3975	4340	4620	4900	5180	30	
	2395	3060	3780	4220	4475	4885	5200	5510	5830	20	
	2660	3400	4200	4690	4970	5425	5775	6125	6475	10	
168 A8 ⇄	2650	3450	4250	4875	5600					40	
	2970	3865	4760	5460	6270					30	
	3340	4345	5355	6145	7055					20	
	3710	4830	5950	6825	7840					10	
150 A8 ⇄	1750	2240	2800	3075	3350					40	
	1960	2510	3135	3445	3750					30	
	2205	2820	3530	3875	4220					20	
	2450	3135	3920	4305	4690					10	
176 A8 ⇄	2755	3540	4330	5015	5700	6360	7100			40	
	3085	3965	4850	5615	6380	7120	7950			30	
	3470	4460	5455	6315	7180	8015	8945			20	
	3855	4960	6060	7020	7975	8905	9940			10	
164 A8 ⇄	1940	2495	3050	3530	4015	4480	5000			40	
	2175	2795	3415	3955	4495	5015	5600			30	
	2445	3145	3840	4450	5055	5645	6300			20	
	2715	3490	4270	4945	5620	6270	7000			10	

Harvester radial tires

Harvester steering wheel

Technical data and load capacities

Tire size	Tread pattern	Rims * (permitted)	Section width (mm)	Overall diameter (mm)	Loaded static radius (mm)	Rolling circumference (mm)	Speed radius index
500/80 R 28 IMP 182 / 162 A8	SFT IMP	DW 16 L W 16 L DW 15 L W 15 L	517 517 507 507	1 495	635 ⊕→ 663 ⊕	4 355 ⊕→ 4 440 ⊕	725
600/65 R 28 IMP 168 / 156 A8	AC 65 IMP	DW 18 L W 18 L W 16 L	590 590 570	1 485	640 ⊕→ 661 ⊕	4 340 ⊕→ 4 411 ⊕	700
600/65 R 28 IMP 177 / 157 A8	AC 65 IMP	DW 18 L W 18 L W 16 L	590 590 570	1 485	640 ⊕→ 661 ⊕	4 340 ⊕→ 4 411 ⊕	700
500/85 R 30 IMP 176 / 164 A8	SFT IMP	DW 16 L W 16 L DW 15 L W 15 L	527 527 517 517	1 605	680 ⊕→ 711 ⊕	4 669 ⊕→ 4 750 ⊕	775
500/85 R 30 IMP 176 / 164 A8	SFT N IMP	DW 16 L W 16 L DW 15 L W 15 L	506 506 496 496	1 605	680 ⊕→ 711 ⊕	4 669 ⊕→ 4 750 ⊕	775
500/85 R 30 IMP 179 / 160 A8	SFT N IMP	DW 16 L W 16 L DW 15 L W 15 L	506 506 496 496	1 606	680 ⊕→ 711 ⊕	4 669 ⊕→ 4 750 ⊕	775

AC 65 IMP



SFT IMP



SFT N IMP



	Service description LI/SS	Tire load capacity (kg) at tire pressure (bar)								Speed (km/h)
		0.8	1.2	1.6	2.0	2.4	2.8	3.2	3.6	
182 A8 ⇄	2 725	3 550	4 375	5 000	5 800	6 500	7 100	7 750	8 500	40
	3 050	3 975	4 900	5 600	6 495	7 280	7 950	8 680	9 520	30
	3 435	4 475	5 515	6 300	7 310	8 190	8 945	9 765	10 710	20
	3 815	4 970	6 125	7 000	8 120	9 100	9 940	10 850	11 900	10
162 A8 ⇄	1 950	2 500	3 000	3 350	3 550	3 875	4 125	4 500	4 750	40
	2 185	2 800	3 360	3 750	3 975	4 340	4 620	5 040	5 320	30
	2 455	3 150	3 780	4 220	4 475	4 885	5 200	5 670	5 985	20
	2 730	3 500	4 200	4 690	4 970	5 425	5 775	6 300	6 650	10
168 A8 ⇄	3 040	3 910	4 775	5 600						40
	3 405	4 380	5 350	6 270						30
	3 830	4 925	6 020	7 055						20
	4 255	5 470	6 690	7 840						10
156 A8 ⇄	2 170	2 790	3 410	4 000						40
	2 430	3 125	3 820	4 480						30
	2 735	3 520	4 300	5 040						20
	3 040	3 910	4 775	5 600						10
177 A8 ⇄	3 075	3 875	4 750	5 600	6 300	7 300				40
	3 445	4 340	5 320	6 270	7 055	8 175				30
	3 875	4 885	5 985	7 055	7 940	9 200				20
	4 305	5 425	6 650	7 840	8 820	10 220				10
157 A8 ⇄	2 060	2 650	3 150	3 550	3 750	4 125				40
	2 305	2 970	3 530	3 975	4 200	4 620				30
	2 595	3 340	3 970	4 475	4 725	5 200				20
	2 885	3 710	4 410	4 970	5 250	5 775				10
176 A8 ⇄	2 995	3 855	4 710	5 445	6 200	7 100				40
	3 355	4 320	5 275	6 100	6 945	7 950				30
	3 775	4 855	5 935	6 860	7 810	8 945				20
	4 195	5 395	6 595	7 625	8 680	9 940				10
164 A8 ⇄	2 110	2 715	3 315	3 840	4 365	5 000				40
	2 365	3 040	3 715	4 300	4 890	5 600				30
	2 660	3 420	4 175	4 840	5 500	6 300				20
	2 955	3 800	4 640	5 375	6 110	7 000				10
176 A8 ⇄	2 995	3 855	4 710	5 445	6 200	7 100				40
	3 355	4 320	5 275	6 100	6 945	7 950				30
	3 775	4 855	5 935	6 860	7 810	8 945				20
	4 195	5 395	6 595	7 625	8 680	9 940				10
164 A8 ⇄	2 110	2 715	3 315	3 840	4 365	5 000				40
	2 365	3 040	3 715	4 300	4 890	5 600				30
	2 660	3 420	4 175	4 840	5 500	6 300				20
	2 955	3 800	4 640	5 375	6 110	7 000				10
179 A8 ⇄	3 000	3 875	4 750	5 450	6 300	7 100	7 750			40
	3 360	4 340	5 320	6 105	7 055	7 950	8 680			30
	3 780	4 885	5 985	6 865	7 940	8 945	9 765			20
	4 200	5 425	6 650	7 630	8 820	9 940	10 850			10
160 A8 ⇄	2 120	2 725	3 250	3 650	3 875	4 250	4 500			40
	2 375	3 050	3 640	4 090	4 340	4 760	5 040			30
	2 670	3 435	4 095	4 600	4 885	5 355	5 670			20
	2 970	3 815	4 550	5 110	5 425	5 950	6 300			10

Harvester steering wheel

Technical data and load capacities

Tire size	Tread pattern	Rims * (permitted)	Section width (mm)	Overall diameter (mm)	Loaded static radius (mm)	Rolling circumference (mm)	Speed radius index	
540/65 R 30 IMP 168 / 156 A8	AC 65 IMP	DW 16 L W 16 L DW 15 L W 15 L DW 18 L W 18 L	534 534 524 524 554 554	1 480	648 ⊕→ 663 ⊕	4 366 ⊕→ 4 420 ⊕	700	
620/70 R 30 IMP 178 / 166 A8	SFT IMP	DW 18 L W 18 L DW 20 B DW 21 B	625 625 645 655	1 595	680 ⊕→ 700 ⊕	4 770 ⊕→ 4 870 ⊕	775	
620/70 R 30 IMP 178 / 166 A8	SFT N IMP	DW 18 L W 18 L DW 20 B DW 21 B	588 588 608 618	1 600	680 ⊕→ 700 ⊕	4 770 ⊕→ 4 870 ⊕	775	
620/75 R 30 IMP 180 / 168 A8	SFT IMP	DW 20 B DW 18 L W 18 L DW 21 B	608 588 588 618	1 690	730 ⊕→ 755 ⊕	4 950 ⊕→ 5 000 ⊕	800	
710/60 R 30 IMP 180 / 162 A8	SFT IMP	DW 23 B DW 21 B	710 690	1 625	680 ⊕→ 724 ⊕	4 690 ⊕→ 4 830 ⊕	775	
710/65 R 30 IMP 182 / 165 A8	SFT IMP	DW 23 B DW 25 B	700 720	1 696	730 ⊕→ 755 ⊕	4 950 ⊕→ 5 000 ⊕	800	

AC 65 IMP



SFT IMP



SFT N IMP



	Service description LI/SS	Tire load capacity (kg) at tire pressure (bar)									Speed (km/h)
		0.8	1.2	1.6	2.0	2.4	2.8	3.2	3.6	4.0	
168 A8 ⇄	2 660	3 420	4 180	4 840	5 600					40	
	2 980	3 830	4 680	5 420	6 270					30	
	3 350	4 310	5 265	6 100	7 055					20	
	3 725	4 790	5 850	6 775	7 840					10	
156 A8 ⇄	1 900	2 445	2 985	3 460	4 000					40	
	2 130	2 740	3 345	3 875	4 480					30	
	2 395	3 080	3 760	4 360	5 040					20	
	2 660	3 425	4 180	4 845	5 600					10	
178 A8 ⇄	3 525	4 535	5 540	6 415	7 500					40	
	3 950	5 075	6 205	7 185	8 400					30	
	4 440	5 710	6 980	8 085	9 450					20	
	4 935	6 345	7 755	8 985	10 500					10	
166 A8 ⇄	2 490	3 205	3 915	4 535	5 300					40	
	2 790	3 590	4 385	5 080	5 935					30	
	3 140	4 035	4 935	5 715	6 680					20	
	3 490	4 485	5 480	6 350	7 420					10	
178 A8 ⇄	3 525	4 535	5 540	6 415	7 500					40	
	3 950	5 075	6 205	7 185	8 400					30	
	4 440	5 710	6 980	8 085	9 450					20	
	4 935	6 345	7 755	8 985	10 500					10	
166 A8 ⇄	2 490	3 205	3 915	4 535	5 300					40	
	2 790	3 590	4 385	5 080	5 935					30	
	3 140	4 035	4 935	5 715	6 680					20	
	3 490	4 485	5 480	6 350	7 420					10	
180 A8 ⇄	3 750	4 875	6 000	6 900	8 000					40	
	4 200	5 460	6 720	7 730	8 960					30	
	4 725	6 145	7 560	8 695	10 080					20	
	5 250	6 825	8 400	9 660	11 200					10	
168 A8 ⇄	2 620	3 410	4 200	4 825	5 600					40	
	2 935	3 820	4 705	5 405	6 270					30	
	3 300	4 295	5 290	6 080	7 055					20	
	3 670	4 775	5 880	6 755	7 840					10	
180 A8 ⇄	3 795	4 875	6 000	6 900	8 000					40	
	4 250	5 460	6 720	7 730	8 960					30	
	4 780	6 145	7 560	8 695	10 080					20	
	5 315	6 825	8 400	9 660	11 200					10	
162 A8 ⇄	2 500	3 250	3 875	4 375	4 750					40	
	2 800	3 640	4 340	4 900	5 320					30	
	3 150	4 095	4 885	5 515	5 985					20	
	3 500	4 550	5 425	6 125	6 650					10	
182 A8 ⇄	4 080	5 250	6 415	7 430	8 500					40	
	4 570	5 880	7 185	8 320	9 520					30	
	5 140	6 615	8 085	9 360	10 710					20	
	5 710	7 350	8 980	10 400	11 900					10	
165 A8 ⇄	2 855	3 570	4 250	4 735	5 150					40	
	3 200	4 000	4 760	5 305	5 770					30	
	3 595	4 500	5 355	5 965	6 490					20	
	3 995	5 000	5 950	6 630	7 210					10	

Harvester steering wheel

Technical data and load capacities

Tire size	Tread pattern	Rims * (permitted)	Section width (mm)	Overall diameter (mm)	Loaded static radius (mm)	Rolling circumference (mm)	Speed radius index
500/85 R 34 IMP 178 / 166 A8	SFT IMP	DW 16 L	525	1 695	745 ⊕→ 755 ⊕	5 000 ⊕→ 5 050 ⊕	825
		W 16 L DW 15 L W 15 L	525 515 515				
500/85 R 34 IMP 178 / 166 A8	SFT N IMP	DW 16 L	505	1 704	745 ⊕→ 755 ⊕	5 000 ⊕→ 5 050 ⊕	825
		W 16 L DW 15 L W 15 L	505 495 495				

* Additional permitted rims may be available on request

- ⊕ drive wheel
- ⊕→ free rolling wheel

When fitted on steering axle, load capacities are 80% of the loads for free-rolling applications.

For intensive road transport at 40/30 km/h the pressure must be increased by 0.4 bar. Maximum inflation pressure should never be exceeded.

All load values are valid for ground slopes up to and including 20% (11°). When operating on slopes greater than 20%, please, contact the producer. Tubeless tires – may be used with a tube.



Service description LI/SS	Tire load capacity (kg) at tire pressure (bar)									Speed (km/h)
	0.8	1.2	1.6	2.0	2.4	2.8	3.2	3.6	4.0	
178 A8 ⊕→	3 620	4 525	4 975	5 760	6 550	7 500				40
	4 055	5 070	5 570	6 450	7 335	8 400				30
	4 560	5 700	6 270	7 260	8 255	9 450				20
	5 070	6 335	6 965	8 065	9 170	10 500				10
166 A8 ⊕	2 555	3 195	3 515	4 070	4 630	5 300				40
	2 860	3 580	3 935	4 560	5 185	5 935				30
	3 220	4 025	4 430	5 130	5 835	6 680				20
	3 575	4 475	4 920	5 700	6 480	7 420				10
178 A8 ⊕→	3 620	4 525	4 975	5 760	6 550	7 500				40
	4 055	5 070	5 570	6 450	7 335	8 400				30
	4 560	5 700	6 270	7 260	8 255	9 450				20
	5 070	6 335	6 965	8 065	9 170	10 500				10
166 A8 ⊕	2 555	3 195	3 515	4 070	4 630	5 300				40
	2 860	3 580	3 935	4 560	5 185	5 935				30
	3 220	4 025	4 430	5 130	5 835	6 680				20
	3 575	4 475	4 920	5 700	6 480	7 420				10

Conversion table

Size designation in inches	Size designation in millimetres				Speed radius index
	95–85 series	80 series	75 series	70 series	
				200/70 R 16	330
				240/70 R 16	350
				260/70 R 16	360
				280/70 R 16	390
				280/70 R 18	410
				280/70 R 20	425
				300/70 R 20	450
11.2 R 20	280/85 R 20	340/80 R 18		320/70 R 20	475
12.4 R 20	320/85 R 20			360/70 R 20	500
11.2 R 24	280/85 R 24			380/70 R 20 320/70 R 24	525
12.4 R 24	320/85 R 24			360/70 R 24	550
13.6 R 24 11.2 R 28	340/85 R 24 280/85 R 28	360/80 R 24		380/70 R 24	575
14.9 R 24 12.4 R 28	380/85 R 24 320/85 R 28	400/80 R 24		420/70 R 24 460/70 R 24	600
16.9 R 24 13.6 R 28	420/85 R 24 340/85 R 28	440/80 R 24		480/70 R 24 500/70 R 24 380/70 R 28	625
14.9 R 28	380/85 R 28	400/80 R 28		420/70 R 28	650
16.9 R 28 14.9 R 30	420/85 R 28 380/85 R 30	440/80 R 28		480/70 R 28 420/70 R 30	675
16.9 R 30	420/85 R 30 500/85 R 24			480/70 R 30	700
18.4 R 30 14.9 R 34	460/85 R 30 380/85 R 34	500/80 R 28		600/70 R 28	725
16.9 R 34 13.6 R 38	420/85 R 34 340/85 R 38	440/80 R 34 380/80 R 38 15.5 R 38	620/75 R 26	600/70 R 30 480/70 R 34	750
18.4 R 34	500/85 R 30 460/85 R 34	480/80 R 34		620/70 R 30 520/70 R 34	775
16.9 R 38	380/95 R 38 420/85 R 38		620/75 R 30	480/70 R 38	800
18.4 R 38	460/85 R 38 500/85 R 34	440/80 R 28		520/70 R 38	825

	Size designation in millimetres				Size designation in inches	Speed radius index
	65 series	60 series	55–50 series	Row Crop		
						330
						350
						360
	320/65 R 16					390
						410
						425
						450
						475
	420/65 R 20					500
						525
						550
	440/65 R 24					575
	480/65 R 24			270/80 R 32	9.5 R 32	600
	540/65 R 24 440/65 R 28			270/95 R 32		625
	480/65 R 28		620/55 R 26	320/85 R 32 270/80 R 36	12.4 R 32 9.5 R 36	650
	540/65 R 28			320/90 R 32 320/85 R 34	12.4 R 34	675
	600/65 R 28 540/65 R 30					700
	600/65 R 30		710/55 R 30	320/85 R 38	13.6 R 36 12.4 R 38	725
	540/65 R 34		750/55 R 30	340/85 R 38 300/85 R 42	13.6 R 38 11.2 R 42	750
	750/65 R 26 600/65 R 34	710/60 R 30 650/60 R 34	1000/50 R 25	300/95 R 42	12.4 R 42	775
	710/65 R 30 540/65 R 38			380/95 R 38 320/90 R 42		800
	650/65 R 34 600/65 R 38	710/60 R 34		320/95 R 46	11.2 R 48	825

Conversion table

Size designation in inches	Size designation in millimetres				Speed radius index
	95–85 series	80 series	75 series	70 series	
20.8 R 38	520/85 R 38	580/80 R 34 540/80 R 38 480/80 R 42	650/75 R 32	580/70 R 38	850
					875
				800/70 R 32	900
20.8 R 42	520/85 R 42 680/85 R 32	480/80 R 46	650/75 R 38	710/70 R 38	925
20.8 R 46	650/85 R 38 580/85 R 42 520/85 R 46	480/80 R 50	650/75 R 42	800/70 R 38 710/70 R 42 900/70 R 32	975
					710/75 R 42
		680/80 R 42			1 025
	480/95 R 50				1 050

All sizes in a row are approximately the same outside diameter.
For specific applications, please contact a producer.

	Size designation in millimetres				Size designation in inches	Speed radius index
	65 series	60 series	55-50 series	Row Crop		
				270/95 R 48		850
	650/65 R 38 800/65 R 32		1050/50 R 32	340/90 R 48	14.9 R 46 13.6 R 48	875
		900/60 R 32		380/90 R 46 320/90 R 50		900
	650/65 R 42					925
				380/90 R 50 320/90 R 54		950
	1000/65 R 32	900/60 R 38	1250/50 R 32		14.9 R 50	975
	710/65 R 46			380/105 R 50 320/105 R 54 380/90 R 54		1 000
		900/60 R 42 750/60 R 46				1 025
				380/105 R 54		1 050



Agriterra 02 SP

LOAD CAPACITY	● ● ● ● ●
ROAD PERFORMANCE	● ● ● ● ●
FIELD PERFORMANCE	● ● ● ● ●
SELF-CLEANING	● ● ● ● ●
RESISTANCE	● ● ● ● ●



Agriterra 02

LOAD CAPACITY	● ● ● ● ●
ROAD PERFORMANCE	● ● ● ● ●
FIELD PERFORMANCE	● ● ● ● ●
SELF-CLEANING	● ● ● ● ●
RESISTANCE	● ● ● ● ●



Agriterra 03

LOAD CAPACITY	● ● ● ● ●
ROAD PERFORMANCE	● ● ● ● ●
FIELD PERFORMANCE	● ● ● ● ●
SELF-CLEANING	● ● ● ● ●
RESISTANCE	● ● ● ● ●



Agriterra 04

LOAD CAPACITY	● ● ● ● ●
ROAD PERFORMANCE	● ● ● ● ●
FIELD PERFORMANCE	● ● ● ● ●
SELF-CLEANING	● ● ● ● ●
RESISTANCE	● ● ● ● ●

Agriterra

New generation of fast and powerful agricultural tires



Agriterra 02, 02 SP & 04 – **Gentle to grassland** due to high positive share and round shoulder.



Agriterra 03 – **Excellent self-cleaning properties** due to higher negative share and distinctive shoulder.



Low noise emission thanks optimized tread pattern.



Wide agricultural use: flat trucks, fast-moving agricultural trailers, tank containers etc.



Agriterra

Technical data and load capacities

Tire size	Tread pattern	Service description LI/SS	Rims * (permitted)	Section width (mm)	Overall diameter (mm)	Loaded static radius (mm)	Rolling circumference (mm)
500/60 R 22.5 IMP	Agriterra 02	161 D	AG 16.00 × 22.5 15.00 × 22.5 16.00 × 22.5 17.00 × 22.5	524	1 172	543	3 547
560/45 R 22.5 IMP	Agriterra 02	152 D	AG 16.00 × 22.5	564	1 076	495	3 228
560/45 R 22.5 IMP	Agriterra 02	160 D	AG 16.00 × 22.5	551	1 080	498	3 261
560/60 R 22.5 IMP	Agriterra 02	165 D	AG 16.00 × 22.5 AG 20.00 × 22.5 16.00 × 22.5 17.00 × 22.5	567 607	1 247	568	3 743
VF 560/60 R 22.5 IMP	Agriterra 02 SP	166 D	AG 16.00 × 22.5 AG 20.00 × 22.5	568 608	1 247	550	3 685
600/50 R 22.5 IMP	Agriterra 02	163 D	AG 20.00 × 22.5	631	1 173	537	3 530
600/50 R 22.5 IMP	Agriterra 02	167 D	AG 20.00 × 22.5	631	1 173	537	3 530
620/40 R 22.5 IMP	Agriterra 02	158 D	AG 20.00 × 22.5	605	1 070	490	3 220
710/45 R 22.5 IMP	Agriterra 02	165 D	AG 24.00 × 22.5 AG 20.00 × 22.5	729	1 208	545	3 610



	Tire load capacity (kg) at tire pressure (bar)										Speed (km/h)
	1.0	1.2	1.6	2.0	2.4	2.8	3.2	3.6	4.0	5.0	
1 730	1 935	2 335	2 735	3 135	3 320	3 505	3 690	3 875	4 125	4 625	65
2 095	2 340	2 825	3 310	3 795	4 015	4 240	4 465	4 690	4 990	5 595	50
2 355	2 630	3 175	3 720	4 265	4 515	4 765	5 020	5 270	5 610	6 290	40
2 610	2 920	3 525	4 130	4 735	5 015	5 295	5 570	5 850	6 230	6 985	30
3 115	3 485	4 205	4 925	5 645	5 975	6 310	6 640	6 975	7 425	8 325	10
1 325	1 480	1 770	2 060	2 360	2 655	2 955	3 250	3 550			65
1 605	1 795	2 145	2 495	2 860	3 215	3 580	3 935	4 300			50
1 805	2 015	2 410	2 805	3 210	3 615	4 020	4 420	4 830			40
2 005	2 235	2 675	3 115	3 565	4 010	4 465	4 910	5 365			30
2 385	2 665	3 190	3 710	4 250	4 780	5 320	5 850	6 390			10
1 325	1 480	1 770	2 060	2 360	2 655	2 955	3 250	3 550	4 000	4 500	65
1 605	1 795	2 145	2 495	2 860	3 215	3 580	3 935	4 300	4 840	5 450	50
1 805	2 015	2 410	2 805	3 210	3 615	4 020	4 420	4 830	5 440	6 590	40
2 005	2 235	2 675	3 115	3 565	4 010	4 465	4 910	5 365	6 045	7 970	30
2 385	2 665	3 190	3 710	4 250	4 780	5 320	5 850	6 390	7 200	9 640	10
2 065	2 305	2 785	3 265	3 745	3 965	4 185	4 405	4 625	5 150		65
2 500	2 790	3 370	3 950	4 530	4 800	5 065	5 330	5 595	6 230		50
2 810	3 135	3 790	4 440	5 095	5 390	5 690	5 990	6 290	7 005		40
3 120	3 480	4 205	4 930	5 655	5 985	6 320	6 650	6 985	7 775		30
3 715	4 150	5 015	5 875	6 740	7 135	7 535	7 930	8 325	9 270		10
2 600	2 915	3 500	3 820	4 295	4 880	5 300					65
3 045	3 415	4 095	4 470	5 030	5 710	6 205					50
3 355	3 765	4 515	4 930	5 545	6 300	6 840					40
3 670	4 115	4 935	5 390	6 060	6 885	7 475					30
4 265	4 785	5 740	6 265	7 045	8 005	8 695					10
1 950	2 175	2 630	3 085	3 535	3 745	3 955	4 165	4 375	4 875		65
2 360	2 630	3 180	3 735	4 275	4 530	4 785	5 040	5 295	5 900		50
2 650	2 960	3 575	4 195	4 810	5 095	5 380	5 665	5 950	6 630		40
2 945	3 285	3 970	4 660	5 340	5 655	5 970	6 290	6 605	7 360		30
3 510	3 915	4 735	5 555	6 365	6 740	7 120	7 495	7 875	8 775		10
1 950	2 175	2 630	3 085	3 535	3 745	3 955	4 165	4 375	4 875	5 450	65
2 360	2 630	3 180	3 735	4 275	4 530	4 785	5 040	5 295	5 900	6 595	50
2 650	2 960	3 575	4 195	4 810	5 095	5 380	5 665	5 950	6 630	7 410	40
2 945	3 285	3 970	4 660	5 340	5 655	5 970	6 290	6 605	7 360	8 230	30
3 510	3 915	4 735	5 555	6 365	6 740	7 120	7 495	7 875	8 775	9 810	10
1 425	1 600	1 950	2 180	2 500	2 800	3 150	3 450	3 750	4 250		65
1 725	1 940	2 360	2 640	3 025	3 390	3 815	4 175	4 540	5 145		50
1 940	2 180	2 655	2 965	3 400	3 810	4 285	4 695	5 100	5 780		40
2 155	2 420	2 945	3 295	3 775	4 230	4 760	5 210	5 665	6 420		30
2 565	2 880	3 510	3 925	4 500	5 040	5 670	6 210	6 750	7 650		10
2 060	2 310	2 820	3 330	3 840	4 170	4 500	4 825	5 150			65
2 495	2 795	3 410	4 030	4 645	5 045	5 445	5 840	6 230			50
2 800	3 140	3 835	4 530	5 220	5 670	6 120	6 560	7 005			40
3 110	3 490	4 260	5 030	5 800	6 295	6 795	7 285	7 775			30
3 710	4 160	5 075	5 995	6 910	7 505	8 100	8 685	9 270			10

Agriterra

Technical data and load capacities

Tire size	Tread pattern	Service description LI/SS	Rims * (permitted)	Section width (mm)	Overall diameter (mm)	Loaded static radius (mm)	Rolling circumference (mm)
620/75 R 26 IMP	Agriterra 02	169 D	DW 20 B × 26 DW 18 B × 26 DW 21 B × 26	625 605 635	1 590	710	4 730
600/55 R 26.5 IMP	Agriterra 02	165 D	AG 20.00 × 26.5	626	1 335	585	4 033
650/55 R 26.5 IMP	Agriterra 02	169 D	AG 20.00 × 26.5	653	1 383	627	4 142
650/65 R 26.5 IMP	Agriterra 02	174 D	AG 20.00 × 26.5	675	1 516	683	4 527
710/50 R 26.5 IMP	Agriterra 02	170 D	AG 24.00 × 26.5 AG 20.00 × 26.5	737	1 388	628	4 189
800/45 R 26.5 IMP	Agriterra 02	174 D	AG 24.00 × 26.5 AG 28.00 × 26.5	770	1 394	628	4 163
600/60 R 30.5 IMP	Agriterra 04	173 D	AG 20.00 × 30.5	625	1 500	690	4 524
680/60 R 30.5 IMP	Agriterra 03	176 D	AG 20.00 × 30.5	697	1 623	740	4 875
710/50 R 30.5 IMP	Agriterra 02	173 D	AG 24.00 × 30.5 AG 20.00 × 30.5	720 680	1 488	680	4 475

Agriterra 02



Agriterra 03



Agriterra 04



	Tire load capacity (kg) at tire pressure (bar)											Speed (km/h)
	1.0	1.2	1.6	2.0	2.4	2.8	3.2	3.6	4.0	5.0	6.0	
2 825	3 150	3 875	4 250	4 750	5 300	5 800						65
3 420	3 810	4 690	5 145	5 750	6 415	7 020						50
3 840	4 285	5 270	5 780	6 460	7 210	7 890						40
4 265	4 755	5 850	6 420	7 175	8 005	8 760						30
5 085	5 670	6 975	7 650	8 550	9 540	10 440						10
2 290	2 560	3 100	3 640	4 180	4 425	4 670	4 910	5 150				65
2 770	3 100	3 750	4 405	5 060	5 355	5 650	5 940	6 230				50
3 115	3 480	4 215	4 950	5 685	6 020	6 350	6 680	7 005				40
3 460	3 865	4 680	5 495	6 310	6 680	7 050	7 415	7 775				30
4 120	4 610	5 580	6 550	7 525	7 965	8 405	8 840	9 270				10
2 590	2 890	3 490	4 095	4 700	4 975	5 250	5 525	5 800				65
3 135	3 495	4 225	4 955	5 685	6 020	6 355	6 685	7 020				50
3 520	3 930	4 745	5 570	6 390	6 765	7 140	7 515	7 890				40
3 910	4 365	5 270	6 185	7 095	7 510	7 930	8 345	8 760				30
4 660	5 200	6 280	7 370	8 460	8 955	9 450	9 945	10 440				10
2 670	3 000	3 660	4 320	4 980	5 410	5 840	6 270	6 700				65
3 230	3 630	4 430	5 225	6 025	6 545	7 065	7 585	8 105				50
3 630	4 080	4 980	5 875	6 775	7 360	7 940	8 525	9 110				40
4 030	4 530	5 525	6 525	7 520	8 170	8 820	9 470	10 115				30
4 805	5 400	6 590	7 775	8 965	9 740	10 510	11 285	12 060				10
2 690	3 000	3 620	4 240	4 860	5 145	5 430	5 715	6 000				65
3 255	3 630	4 380	5 130	5 880	6 225	6 570	6 915	7 260				50
3 660	4 080	4 925	5 765	6 610	6 995	7 385	7 770	8 160				40
4 060	4 530	5 465	6 400	7 340	7 770	8 200	8 630	9 060				30
4 840	5 400	6 515	7 630	8 750	9 260	9 775	10 285	10 800				10
2 670	3 000	3 660	4 320	4 980	5 410	5 840	6 270	6 700				65
3 230	3 630	4 430	5 225	6 025	6 545	7 065	7 585	8 105				50
3 630	4 080	4 980	5 875	6 775	7 360	7 940	8 525	9 110				40
4 030	4 530	5 525	6 525	7 520	8 170	8 820	9 470	10 115				30
4 805	5 400	6 590	7 775	8 965	9 740	10 510	11 285	12 060				10
2 590	2 890	3 490	4 095	4 700	4 975	5 250	5 525	5 800	6 500			65
3 135	3 495	4 225	4 955	5 685	6 020	6 355	6 685	7 020	7 865			50
3 520	3 930	4 745	5 570	6 390	6 765	7 140	7 515	7 890	8 840			40
3 910	4 365	5 270	6 185	7 095	7 510	7 930	8 345	8 760	9 815			30
4 660	5 200	6 280	7 370	8 460	8 955	9 450	9 945	10 440	11 700			10
3 170	3 540	4 280	5 020	5 760	6 095	6 430	6 765	7 100				65
3 840	4 285	5 180	6 075	6 970	7 375	7 785	8 190	8 595				50
4 315	4 815	5 825	6 830	7 835	8 290	8 745	9 205	9 660				40
4 790	5 350	6 465	7 585	8 700	9 205	9 710	10 220	10 725				30
5 710	6 375	7 705	9 040	10 370	10 975	11 575	12 180	12 780				10
2 410	2 725	3 350	3 750	4 375	4 875	5 450	6 000	6 500				65
2 920	3 300	4 055	4 540	5 295	5 900	6 595	7 260	7 865				50
3 280	3 710	4 560	5 100	5 950	6 630	7 415	8 160	8 840				40
3 640	4 115	5 060	5 665	6 610	7 365	8 230	9 060	9 815				30
4 340	4 905	6 030	6 750	7 875	8 775	9 810	10 800	11 700				10

Agriterra

Technical data and load capacities

Tire size	Tread pattern	Service description LI/SS	Rims * (permitted)	Section width (mm)	Overall diameter (mm)	Loaded static radius (mm)	Rolling circumference (mm)
750/60 R 30.5 IMP	Agriterra 03	181 D	AG 24.00 × 30.5	792	1 672	755	4 998
850/50 R 30.5 IMP	Agriterra 02	182 D	AG 28.00 × 30.5	880	1 620	732	4 844
800/65 R 32 IMP	Agriterra 04	185 D	DW 25 B × 32 DW 23 B × 32 DW 27 B × 32 DW 28 B × 32	785 765 805 815	1 859	835	5 442

* Additional permitted rims may be available on request

For intensive road transport at 65/50/40/30 km/h the pressure must be increased by 0.4 bar. Maximum inflation pressure should never be exceeded. All load values are valid for ground slopes up to and including 20% (11°). When operating on slopes greater than 20%, please, contact the producer. Tubeless tires – may be used with a tube.

Agriterra 02



Agriterra 03



Agriterra 04



	Tire load capacity (kg) at tire pressure (bar)										Speed (km/h)	
	1.0	1.2	1.6	2.0	2.4	2.8	3.2	3.6	4.0	5.0		6.0
	3 680	4 110	4 970	5 830	6 690	7 080	7 470	7 860	8 250			65
	4 455	4 975	6 015	7 055	8 095	8 565	9 040	9 510	9 985			50
	5 005	5 590	6 760	7 930	9 100	9 630	10 160	10 690	11 220			40
	5 555	6 205	7 505	8 805	10 100	10 690	11 280	11 870	12 460			30
	6 625	7 400	8 945	10 495	12 040	12 745	13 445	14 150	14 850			10
	3 400	3 820	4 660	5 500	6 340	6 880	7 420	7 960	8 500			65
	4 115	4 620	5 640	6 655	7 670	8 325	8 980	9 630	10 285			50
	4 625	5 195	6 340	7 480	8 620	9 355	10 090	10 825	11 560			40
	5 135	5 770	7 035	8 305	9 575	10 390	11 205	12 020	12 835			30
	6 120	6 875	8 390	9 900	11 410	12 385	13 355	14 330	15 300			10
	4 025	4 500	5 450	6 150	6 900	7 750	8 500	9 250				65
	4 870	5 445	6 595	7 440	8 350	9 380	10 285	11 195				50
	5 475	6 120	7 410	8 365	9 385	10 540	11 560	12 580				40
	6 080	6 795	8 230	9 285	10 420	11 705	12 835	13 970				30
	7 245	8 100	9 810	11 070	12 420	13 950	15 300	16 650				10



AR-01

Approved for high speed up to 80 km/h. Reduced fuel consumption. Prolonged working life.



AR-02

High-grip thanks to robust lugs. Optimal pressure distribution. Balanced handling on and off the road.



AR-03

Radial tire designed for use on fastmoving self-loading forage boxes and trailers at speeds of up to 65 km/h. The larger footprint and low tire pressure protect both grassland and soil. The tire is also suitable for utility vehicles.



AR-04

Radial traction tire for use on grassland. Ideally suited for working on slopes. Very quiet running on roads at speeds of up to 65 km/h. High mileage performance through optimized tread pattern design.



AR-05

The longitudinal and lateral structure of the tread pattern, combined with rounded tread shoulders, ensures low rolling resistance. The all-steel construction protects the tire from damage. Approved for speeds of up to 100 km/h.



AR-06

Special radial traction tire for field use. Excellent traction performance through optimized lug design. The large footprint thanks to the wide tread area.

AR – Agricultural radial tires with high load capacity and working speed

Main applications – Trailer radial tires

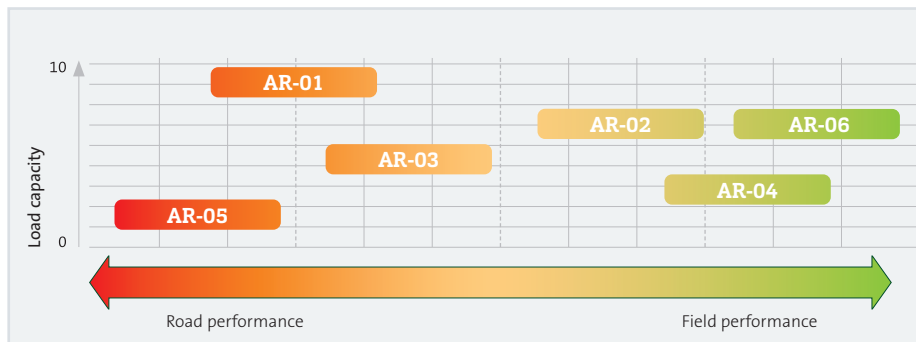

Trailer radial tires



Trailer radial tires

Technical data and load capacities

Tire size	Tread pattern	Service description LI/SS	Rims * (permitted)	Section width (mm)	Overall diameter (mm)	Loaded static radius (mm)	Rolling circumference (mm)
385/65 R 22.5 (15 R 22.5)	AR-01	161 F	11.75 × 22.5	389	1 072	485	3 248
445/65 R 22.5 (18 R 22.5)	AR-01	169 F	14.00 × 22.5	454	1 150	514	3 484

Tire size	Tread pattern	Service description LI/SS	Rims * (permitted)	Section width (mm)	Overall diameter (mm)	Loaded static radius (mm)	Rolling circumference (mm)
460/65 R 22.5 IMP	AR-01	168 A8 / 156 A8	14.00 × 22.5 (15.00 × 22.5, 16.00 × 22.5)	450	1 170	550	3 456

* Additional permitted rims may be available on request

For intensive road transport at 80/65/50/40/30 km/h the pressure must be increased by 0.4 bar. Maximum inflation pressure should never be exceeded. All load values are valid for ground slopes up to and including 20% (11°). When operating on slopes greater than 20%, please, contact the producer. Tubeless tires – may be used with a tube.



Tire load capacity (kg) at tire pressure (bar)												Speed (km/h)
4.0	4.5	5.0	5.5	6.0	6.5	7.0	7.5	8.0	8.5	9.0		
		2 600	2 800	3 000	3 200	3 400	3 600	3 850	4 100	4 625	80	
		2 795	3 010	3 225	3 440	3 655	3 870	4 140	4 410	4 970	65	
		2 910	3 135	3 360	3 585	3 810	4 030	4 310	4 590	5 180	50	
		2 990	3 220	3 450	3 680	3 910	4 140	4 430	4 715	5 319	40	
		3 250	3 500	3 750	4 000	4 250	4 500	4 815	5 125	5 781	30	
		4 680	5 040	5 400	5 760	6 120	6 480	6 930	7 380	8 325	10	
3 200	3 500	3 800	4 100	4 400	4 700	5 000	5 300	5 800			80	
3 440	3 765	4 085	4 410	4 730	5 055	5 375	5 700	6 235			65	
3 585	3 920	4 255	4 590	4 930	5 265	5 600	5 935	6 495			50	
3 680	4 025	4 370	4 715	5 060	5 405	5 750	6 095	6 670			40	
4 000	4 375	4 750	5 125	5 500	5 875	6 250	6 625	7 250			30	
5 760	6 300	6 840	7 380	7 920	8 460	9 000	9 540	10 440			10	

Tire load capacity (kg) at tire pressure (bar)											Speed (km/h)
0.8	1.2	1.6	2.0	2.4	2.8	3.2	3.6	4.0	5.0		
1 510	1 965	2 420	2 770	3 225	3 680	3 930	4 335	4 740	5 040	50	
1 680	2 185	2 690	3 080	3 585	4 090	4 370	4 815	5 265	5 600	40	
1 880	2 445	3 010	3 450	4 015	4 580	4 890	5 395	5 895	6 270	30	
2 115	2 750	3 385	3 880	4 515	5 150	5 505	6 070	6 635	7 055	20	
2 350	3 060	3 765	4 310	5 020	5 725	6 115	6 740	7 370	7 840	10	

Trailer radial tires

Technical data and load capacities

Tire size	Tread pattern	Service description LI/SS	Rims * (permitted)	Section width (mm)	Overall diameter (mm)	Loaded static radius (mm)	Rolling circumference (mm)
440/50 R 17 IMP	AR-04 All terrain	135 D	14.00 × 17 13.00 × 17	441 431	873	393	2 605
500/50 R 17 IMP	AR-03 Universal service	149 D	16.00 × 17	502	933	425	2 800
560/60 R 22.5 IMP	AR-02	161 D	AG 16.00 × 22.5 AG 20.00 × 22.5 16.00 × 22.5 17.00 × 22.5	546 586 546	1 248	563	3 793

Tire size	Tread pattern	Service description LI/SS	Rims * (permitted)	Tube Valve	Section width (mm)	Overall diameter (mm)	Loaded static radius (mm)	Rolling circumference (mm)
355/60 R 18 MPT	AR-05 AG trailer	142 J	11 × 18	(43 GS 16)** 10.5/80- /13.0/65-18; 355/60-18 T	352	890	398	2 650

** Valve 50 GW optional

Tire size	Tread pattern	Rims * (permitted)	Section width (mm)	Overall diameter (mm)	Loaded static radius (mm)	Rolling circumference (mm)
500/40 R 17 IMP	AR-06	DW 16L × 17 W 16L × 17 DW 14L × 17 W 14L × 17	490 490 470 470	832	380 ⊕→ 390 ⊕	2 495 ⊕→ 2 250 ⊕

* Additional permitted rims may be available on request

For intensive road transport at 100/80/65/50/40/30 km/h the pressure must be increased by 0.4 bar. Maximum inflation pressure should never be exceeded. All load values are valid for ground slopes up to and including 20% (11°). When operating on slopes greater than 20%, please, contact the producer. Tubeless tires – may be used with a tube.

When fitted on steering axle, load capacities are 80% of the loads for free-rolling applications.



Tire load capacity (kg) at tire pressure (bar)											Speed (km/h)
0.8	1.0	1.2	1.6	2.0	2.4	2.8	3.2	3.6	4.0	5.0	
	870	950	1100	1430	1575	1715	2040	2180			65
1 075	1185	1295	1500	1940	2145	2330	2775	2965			40
1 190	1315	1435	1665	2155	2380	2585	3080	3290			30
1 420	1570	1715	1985	2570	2840	3085	3670	3925			10
			1150	1505	1680	1845	2200	2665	–	3 250	65
			1740	2275	2540	2785	3330	4030	–	4 420	40
			1930	2530	2825	3090	3695	4470	–	4 910	30
			2305	3015	3365	3685	4405	5330	–	5 850	10
	2 065	2 305	2 785	3 265	3 745	3 965	4 185	4 405	4 625		65
	2 500	2 790	3 370	3 950	4 530	4 800	5 065	5 330	5 595		50
	2 810	3 135	3 790	4 440	5 095	5 390	5 690	5 990	6 290		40
	3 120	3 480	4 205	4 930	5 655	5 985	6 320	6 650	6 985		30
	3 715	4 150	5 015	5 875	6 740	7 135	7 535	7 930	8 325		10

Tire load capacity (kg) at tire pressure (bar)									Speed (km/h)
1.6	2.0	2.5	3.0	3.5	4.0	4.5	5.0		
1 030	1 220	1 460	1 700	1 930	2 170	2 410	2 650	100	
1 120	1 320	1 580	1 840	2 090	2 350	2 610	2 880	65	

Service description L/SS	Tire load capacity (kg) at tire pressure (bar)										Speed (km/h)
	1.2	1.6	2.0	2.4	2.8	3.2	3.6	4.0	5.0		
154 A8 ⊕	1 450	1 800	2 060	2 360	2 630	2 900	3 175	3 450	3 750	40	
	1 625	2 015	2 305	2 645	2 945	3 250	3 555	3 865	4 200	30	
	1 825	2 270	2 595	2 975	3 315	3 655	4 000	4 345	4 725	20	
	2 030	2 520	2 885	3 305	3 680	4 060	4 445	4 830	5 250	10	
142 A8 ⊕	1 030	1 250	1 450	1 700	1 880	2 060	2 245	2 430	2 650	40	
	1 155	1 400	1 625	1 905	2 105	2 305	2 510	2 720	2 970	30	
	1 300	1 575	1 825	2 140	2 365	2 595	2 825	3 060	3 340	20	
	1 440	1 750	2 030	2 380	2 630	2 885	3 140	3 400	3 710	10	



HCM

LOAD CAPACITY



TRACTION



SELF-CLEANING



HANDLING ON ROAD



HCM (High Capacity Municipal)

All-purpose quiet running tire for all terrains and applications



Particularly suitable for municipal and road maintenance tractors and equipment. Designed for **all-season use**.



High durability due to steel belted radial construction and unique design of tread pattern in the central part.



Exceptional traction characteristics incorporating an innovative lug design to increase grip on a wide range of surfaces.



Excellent self-cleaning and **very good steering characteristics**.



Low noise emission and vibration characteristics due to utilizing the randomization design process that varies the lug pitches, lug lengths and lug alignment for a quieter and smoother ride.

Pitches with the same length

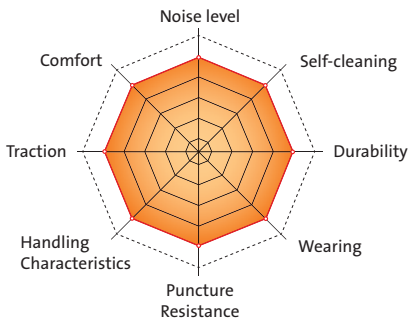

Pitches with different length

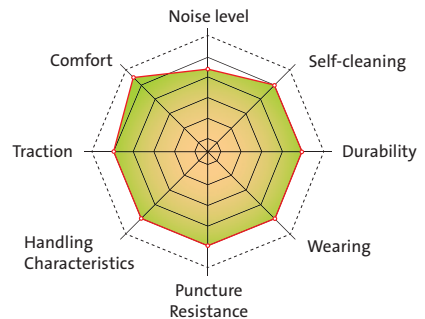

Municipal tires – reduction of noise emission

The same length of pitches – spectrum comprises periodic lines with high amplitude (all noise concentrated into multiple repeated basic frequency – formation of disturbing noise).

Different length of pitches and their alignment gives a spectrum with low amplitude – noise is divided into whole frequency range – reduction of disturbing noise.

HCM

Technical data and load capacities

Tire size	Service description LI/SS	Rims * (permitted)	Section width (mm)	Overall diameter (mm)	Loaded static radius (mm)	Rolling circumference (mm)	Speed radius index	
340/80 R 18 IND	138 D (143 A8)	11 W 10 W 11 W 12, 12	345 335 345 355	999	460	3 015	475	
360/80 R 20 IND	143 D (147 A8)	11 W 10 W 11 W 12, 12	364 354 364 374	1 081	495	3 255	525	
360/80 R 24 IND	139 D (144 A8)	DW 11 DW 10, W 10 W 11 DW 12, W 12	360 350 360 370	1 184	545	3 570	575	
400/80 R 24 IND	144 D (149 A8)	DW 13 DW 12, W 12 W 13 DW 14 L, W 14 L	406 396 406 416	1 251	575	3 770	600	
440/80 R 24 IND	149 D (154 A8)	DW 14 L W 15 L, DW 15 L	464 474	1 318	600	3 955	625	
360/80 R 28 IND	141 D (146 A8)	DW 11 W 11 DW 12, W 12 DW 13, W 13	364 364 374 384	1 286	595	3 890	625	
400/80 R 28 IND	146 D (151 A8)	DW 13 DW 12, 12 W 13 DW 14 L, W 14 L	410 400 410 420	1 354	625	4 090	650	
440/80 R 28 IND	151 D (156 A8)	DW 14 L DW 15 L, W 15 L DW 16 L, W 16 L	455 465 475	1 413	675	4 260	675	



	Tire load capacity (kg) at tire pressure (bar)								Speed (km/h)
	1.2	1.6	2.0	2.4	2.8	3.2	3.5	4.0	
925	1135	1345	1535	1745	1960	2100	2 360	65	
995	1225	1455	1660	1885	2115	2270	2 550	50	
1065	1310	1555	1770	2015	2260	2425	2 725	40	
1105	1360	1615	1845	2100	2355	2525	2 835	30	
1160	1425	1695	1930	2200	2465	2645	2 970	20	
1330	1635	1940	2215	2520	2825	3030	3 405	10	
1065	1310	1555	1770	2015	2260	2425	2 725	65	
1150	1415	1680	1915	2180	2445	2620	2 945	50	
1200	1475	1755	2000	2275	2550	2735	3 075	40	
1250	1535	1825	2080	2370	2655	2850	3 200	30	
1305	1610	1910	2180	2480	2780	2980	3 350	20	
1500	1845	2190	2500	2845	3190	3420	3 845	10	
1140	1410	1650	1920	2165	2 430			65	
1235	1525	1785	2075	2335	2625			50	
1315	1625	1905	2210	2490	2 800			40	
1370	1690	1980	2300	2590	2910			30	
1435	1770	2075	2410	2715	3050			20	
1645	2030	2380	2765	3115	3500			10	
1315	1625	1905	2210	2490	2 800			65	
1420	1755	2055	2390	2690	3025			50	
1530	1885	2210	2570	2895	3 250			40	
1590	1960	2300	2670	3010	3380			30	
1665	2055	2410	2800	3155	3545			20	
1910	2360	2765	3210	3620	4065			10	
1530	1885	2210	2570	2895	3 250			65	
1650	2035	2385	2775	3125	3510			50	
1765	2175	2550	2965	3340	3 750			40	
1835	2260	2650	3080	3470	3900			30	
1920	2370	2780	3230	3640	4090			20	
2205	2720	3190	3705	4175	4690			10	
1210	1495	1750	2035	2290	2 575			65	
1305	1610	1890	2195	2475	2780			50	
1410	1740	2040	2370	2670	3 000			40	
1465	1810	2120	2465	2775	3120			30	
1535	1895	2225	2585	2910	3270			20	
1765	2175	2550	2965	3340	3750			10	
1410	1740	2040	2370	2670	3 000			65	
1525	1880	2205	2560	2885	3240			50	
1620	2000	2345	2725	3070	3 450			40	
1685	2080	2440	2835	3195	3590			30	
1765	2180	2555	2970	3345	3760			20	
2030	2505	2935	3410	3840	4315			10	
1620	2000	2345	2725	3070	3 450			65	
1750	2160	2535	2945	3315	3725			50	
1880	2320	2720	3160	3560	4 000			40	
1955	2415	2830	3285	3700	4160			30	
2050	2530	2965	3445	3880	4360			20	
2350	2900	3400	3950	4450	5000			10	

Municipal, Agro-industrial and Multipurpose tires

HCM

Technical data and load capacities

Tire size	Service description LI/SS	Rims * (permitted)	Section width (mm)	Overall diameter (mm)	Loaded static radius (mm)	Rolling circumference (mm)	Speed radius index
440/80 R 30 IND	153 D (157 A8)	DW 14 L DW 15 L DW 16 L	442 452 462	1 465	670	4 405	700
540/65 R 30 IND	156 D (161 A8)	DW 18 L DW 16 L, W 16 L DW 18 L	546 526 546	1 463	675	4 420	700
440/80 R 34 IND	155 D (159 A8)	DW 14 L DW 15 L DW 16 L	456 466 476	1 567	720	4 725	750
480/80 R 34 IND	159 D (164 A8)	DW 15 L DW 16 L DW 18 L	494 504 524	1 636	745	4 910	775
480/80 R 38 IND	161 D (166 A8)	DW 15 L DW 16 L DW 18 L	504 514 534	1 738	800	5 245	825
540/80 R 38 IND	167 D (172 A8)	DW 18 L DW 16 L	575 555	1 837	845	5 540	875
650/65 R 42 IND	171 D (176 A8)	DW 20 B DW 18 L DW 23 B	641 621 671	1 916	885	5 790	925

* Additional permitted rims may be available on request

All load values are valid for ground slopes up to and including 20% (11°). When operating on slopes greater than 20%, please, contact the producer.
Tubeless tires – may be used with a tube.



	Tire load capacity (kg) at tire pressure (bar)							Speed (km/h)
	1.2	1.6	2.0	2.4	2.8	3.2	3.5	
1 715	2 115	2 480	2 885	3 250	3 650			65
1 850	2 285	2 680	3 115	3 505	3 940			50
1 940	2 395	2 805	3 260	3 670	4 125			40
2 015	2 490	2 915	3 390	3 820	4 290			30
2 115	2 605	3 055	3 550	4 000	4 495			20
2 425	2 990	3 505	4 070	4 590	5 155			10
1 880	2 320	2 720	3 160	3 560	4 000			65
2 030	2 505	2 940	3 415	3 845	4 320			50
2 175	2 685	3 145	3 655	4 115	4 625			40
2 260	2 790	3 270	3 800	4 280	4 810			30
2 370	2 925	3 425	3 980	4 485	5 040			20
2 715	3 350	3 930	4 565	5 145	5 780			10
1 820	2 250	2 635	3 060	3 450	3 875			65
1 965	2 425	2 845	3 305	3 725	4 185			50
2 055	2 540	2 975	3 455	3 895	4 375			40
2 140	2 640	3 095	3 595	4 050	4 550			30
2 240	2 765	3 245	3 770	4 245	4 770			20
2 570	3 175	3 720	4 320	4 870	5 470			10
2 055	2 540	2 975	3 455	3 895	4 375			65
2 220	2 740	3 215	3 735	4 205	4 725			50
2 350	2 900	3 400	3 950	4 450	5 000			40
2 445	3 015	3 535	4 110	4 630	5 200			30
2 560	3 160	3 705	4 305	4 850	5 450			20
2 940	3 625	4 250	4 940	5 565	6 250			10
2 175	2 685	3 145	3 655	4 115	4 625			65
2 350	2 895	3 395	3 945	4 445	4 995			50
2 490	3 075	3 605	4 185	4 715	5 300			40
2 590	3 195	3 745	4 355	4 905	5 510			30
2 715	3 350	3 925	4 560	5 140	5 775			20
3 115	3 840	4 505	5 235	5 895	6 625			10
2 560	3 160	3 705	4 305	4 850	5 450			65
2 765	3 415	4 000	4 650	5 240	5 885			50
2 960	3 655	4 285	4 975	5 605	6 300			40
3 080	3 800	4 455	5 175	5 830	6 550			30
3 225	3 980	4 670	5 425	6 110	6 865			20
3 700	4 570	5 355	6 220	7 010	7 875			10
2 890	3 565	4 180	4 860	5 475	6 150			65
3 120	3 850	4 515	5 245	5 910	6 640			50
3 335	4 120	4 830	5 610	6 320	7 100			40
3 470	4 285	5 020	5 835	6 575	7 385			30
3 640	4 490	5 265	6 115	6 890	7 740			20
4 170	5 150	6 035	7 010	7 900	8 875			10

Municipal, Agro-industrial and Multipurpose tires



TI-20

TRACTION	●●●●●●●●
SERVICE LIFE	●●●●●●●●
RESISTANCE	●●●●●●●●
SELF-CLEANING	●●●●●●●●

Agro-industrial radial tires

Universal tires for industrial and agricultural application

TI-20

New generation of tread pattern.

Suitable for **construction, road and agricultural work.**

Priority to traction.

Designed for **muddy conditions.**

Very good resistance to damage.



Agro-industrial TI

Technical data and load capacities

Tire size	Tread pattern Type	Service description LI/SS	Rims (permitted)	Section width (mm)	Overall diameter (mm)	Loaded static radius (mm)	Rolling circumference (mm)
340/80 R 18 IND	TI-20 TL	143 A8	11×18 (12×18, W 10×18, W 11×18)	343	1 001	449	2 993
480/80 R 26 IND	TI-20 TL	160 A8	DW 15 L×26 (DW 16 L×26)	500	1 428	640	4 250
440/70 R 28 IND	AC 70 G TL	160 A8	W 13 W 14 L W 15	435 445 455	1 348	604	4 027

For intensive road transport at 65/50/40/30 km/h the pressure must be increased by 0.4 bar. Maximum inflation pressure should never be exceeded. All load values are valid for ground slopes up to and including 20% (11°). When operating on slopes greater than 20%, please, contact the producer. Tubeless tires - may be used with a tube.

AC 70 G



TI-20



	Tire load capacity (kg) at speed (km/h)							Tire pressure (bar)
	0	10	10 Cyclic	20	30	40	50	
3 760	2 045	2 450	1 780	1 700	1 635	1 570	2.0	
4 390	2 390	2 865	2 080	1 985	1 910	1 740	2.5	
5 015	2 725	3 270	2 375	2 270	2 180	1 985	3.0	
5 635	3 060	3 675	2 670	2 550	2 450	2 230	3.5	
6 265	3 405	4 090	2 970	2 835	2 725	2 480	4.0	
7 073	3 844	4 613	3 352	3 198	3 075	2 798	2.0	
7 705	4 188	5 025	3 652	3 484	3 350	3 049	2.2	
8 165	4 438	5 325	3 870	3 692	3 550	3 231	2.4	
8 625	4 688	5 625	4 088	3 900	3 750	3 413	2.6	
9 200	5 000	6 000	4 360	4 160	4 000	3 640	2.8	
9 775	5 313	6 375	4 633	4 420	4 250	3 868	3.0	
10 350	5 625	6 750	4 905	4 680	4 500	4 095	3.2	
5 715	3 080	3 725	2 710	2 585	2 485	2 485	2.0	
6 125	3 300	3 995	2 900	2 770	2 665	2 665	2.2	
6 530	3 520	4 260	3 095	2 950	2 840	2 840	2.4	
6 940	3 740	4 525	3 290	3 135	3 020	3 020	2.6	
7 350	3 995	4 790	3 485	3 320	3 195	3 195	2.8	
7 755	4 220	5 060	3 675	3 505	3 370	3 370	3.0	
8 165	4 440	5 325	3 870	3 690	3 550	3 550	3.2	



AC 70 G

LOAD CAPACITY	● ● ● ● ●
ROAD PERFORMANCE	● ● ● ● ● ●
FIELD PERFORMANCE	● ● ● ● ●
SELF-CLEANING	● ● ● ● ● ●
RESISTANCE	● ● ● ● ●

AC 70 G

Universal radial multipurpose tire (MPT)



Stable, safe and comfortable running on the road, thanks to a wide tread area and large lug overlap in the tread centre.



Economical thanks to low wear.



Tires in the MPT range have a special casing and steel belt for **high speeds up to 90 km/h**.



Multipurpose radial tires

Technical data and load capacities

Tire size	Tread pattern Type	Service description LI/SS	Rims * (permitted)	Section width (mm)	Overall diameter (mm)	Loaded static radius (mm)	Rolling circumference (mm)	
265/70 R 16 MPT	AC 70 G TL	114 G	8 9 7	261 271 251	775	354	2 333	
285/80 R 16 MPT	AC 70 G TL	126 G	10 9	308 298	866	370	2 540	
425/55 R 17 MPT	AC 70 G TL	134 G	13	428	884	399	2 642	
425/55 R 17 MPT	AC 70 G TL	141 G	13	428	884	399	2 642	
325/70 R 18 MPT	AC 70 G TL	125 G	10 11 9	321 331 311	918	421	2 765	
365/70 R 18 MPT	AC 70 G TL	132 G	11 12 10	365 375 355	978	449	2 947	
275/80 R 20 MPT	AC 70 G TL	131 G	9	274	966	446	2 890	



											Speed (km/h)		
0.8	1.0	1.2	1.4	1.6	2.0	2.5	3.0	3.5	4.0	4.5	5.0	6.0	
	460	510	570	630	740	880	1 030	1 180					90
	490	560	620	680	800	960	1 120	1 280					65
	510	570	640	700	830	1 000	1 160	1 320					50
460	520	590	650	720	850	1 020	1 190	1 360					40
500	570	640	710	780	930	1 110	1 300	1 480					30
720	820	920	1 030	1 130	1 330	1 600	1 860	2 120					10
									(4.25 bar)				
	570	650	720	790	930	1 110	1 280	1 450	1 700				90
	620	700	780	860	1 010	1 200	1 390	1 570	1 840				65
	640	720	800	880	1 040	1 240	1 430	1 620	1 900				50
580	660	740	820	910	1 070	1 270	1 470	1 670	1 950				40
630	720	810	900	990	1 170	1 380	1 600	1 810	2 120				30
900	1 030	1 160	1 290	1 420	1 680	1 990	2 300	2 610	3 060				10
	780	880	980	1 080	1 280	1 550	1 830	2 120					90
	850	960	1 070	1 170	1 390	1 680	1 990	2 300					65
	880	990	1 100	1 210	1 430	1 740	2 050	2 370					50
790	900	1 020	1 130	1 240	1 470	1 780	2 100	2 440					40
860	980	1 110	1 230	1 350	1 600	1 940	2 290	2 650					30
1 240	1 410	1 590	1 770	1 940	2 300	2 790	3 290	3 820					10
	780	880	980	1 080	1 280	1 550	1 830	2 120	2 575				90
	850	960	1 070	1 170	1 390	1 680	1 990	2 300	2 795				65
	880	990	1 100	1 210	1 430	1 740	2 050	2 370	2 885				50
790	900	1 020	1 130	1 240	1 470	1 780	2 100	2 440	2 960				40
860	980	1 110	1 230	1 350	1 600	1 940	2 290	2 650	3 220				30
1 240	1 410	1 590	1 770	1 940	2 300	2 790	3 290	3 820	4 635				10
	660	740	820	900	1 060	1 260	1 460	1 650					90
	710	800	890	980	1 150	1 370	1 580	1 790					65
	740	830	920	1 010	1 200	1 410	1 630	1 850					50
660	760	850	950	1 040	1 230	1 460	1 680	1 900					40
720	820	930	1 030	1 130	1 340	1 570	1 820	2 060					30
1 040	1 180	1 330	1 480	1 630	1 920	2 270	2 620	2 970					10
	790	890	980	1 080	1 280	1 520	1 760	2 000					90
	860	960	1 070	1 170	1 380	1 650	1 910	2 170					65
	880	990	1 100	1 210	1 440	1 700	1 970	2 240					50
790	910	1 020	1 130	1 250	1 470	1 750	2 020	2 300					40
860	990	1 110	1 230	1 360	1 600	1 900	2 200	2 500					30
1 240	1 420	1 600	1 770	1 950	2 300	2 730	3 170	3 600					10
									(4.75 bar)				
	600	670	750	820	970	1 160	1 340	1 510	1 690	1 950			90
	650	730	810	890	1 060	1 250	1 450	1 640	1 830	2 120			65
	670	760	840	920	1 090	1 290	1 500	1 690	1 890	2 180			50
600	690	780	860	950	1 120	1 330	1 540	1 730	1 940	2 240			40
660	750	840	940	1 030	1 220	1 440	1 670	1 890	2 110	2 440			30
940	1 080	1 210	1 350	1 480	1 750	2 080	2 400	2 720	3 040	3 510			10

Multipurpose radial tires

Technical data and load capacities

Tire size	Tread pattern Type	Service description L/SS	Rims * (permitted)	Section width (mm)	Overall diameter (mm)	Loaded static radius (mm)	Rolling circumference (mm)	
335/80 R 20 MPT	AC 70 G TL	134 G	11 10	320 310	1 048	485	3 168	
365/80 R 20 MPT (14.5 R 20)	MPT-21 TL	152 J	11 12	360	1 092	493	3 276	
375/70 R 20 MPT	AC 70 G TL	136 G	11 12	375 385	1 034	471	3 107	
405/70 R 20 MPT	AC 70 G TL	136 G	11 13	405 425	1 065	485	3 225	
405/70 R 20 MPT (16/70 R 20)	MPT-21 TL	152 J	13 12	407	1 076	492	3 228	
425/75 R 20 MPT	AC 70 G TL	148 G	13 11	441 421	1 148	521	3 440	
425/75 R 20 MPT	AC 70 G TL	158 G	13 13 SDC 11	441 441 421	1 148	521	3 440	

AC 70 G



MPT-21



											Speed (km/h)			
0.8	1.0	1.2	1.4	1.6	2.0	2.5	3.0	3.5	4.0	4.5	5.0	6.0		
	810	920	1020	1120	1330	1590	1870	2 120					90	
	880	990	1110	1220	1440	1730	2 010	2 300					65	
	910	1 030	1 140	1 250	1 480	1 780	2 080	2 380					50	
820	940	1 050	1 170	1 290	1 520	1 820	2 130	2 440					40	
890	1 020	1 150	1 270	1 400	1 650	1 990	2 320	2 650					30	
1 280	1 460	1 650	1 830	2 010	2 380	2 870	3 340	3 820					10	
				1 040	1 170	1 435	1 710	1 985	2 180	2 370	2 645	2 915	(6.25 bar) 3 550	100
				1 090	1 225	1 490	1 775	2 060	2 265	2 470	2 745	3 025	3 710	80
				1 120	1 250	1 520	1 810	2 100	2 315	2 530	2 815	3 095	3 800	70
				1 165	1 310	1 605	1 915	2 225	2 440	2 655	2 960	3 265	3 975	50
				1 190	1 330	1 620	1 940	2 255	2 490	2 725	3 025	3 325	4 080	40
				1 650	1 840	2 225	2 660	3 090	3 440	3 790	4 195	4 595	5 600	10
	755	860	970	1 080	1 180	1 400	1 630	1 850	2 240					90
	820	930	1 050	1 170	1 280	1 520	1 770	2 005	2 430					65
	845	960	1 085	1 215	1 320	1 570	1 825	2 070	2 510					50
	870	990	1 115	1 245	1 355	1 610	1 875	2 130	2 575					40
	945	1 085	1 215	1 350	1 475	1 750	2 040	2 315	2 800					30
1 360	1 550	1 745	1 940	2 125	2 520	2 935	3 330	4 030						10
		970	1 090	1 210	1 340	1 580	1 820	2 040	2 240					90
		1 050	1 190	1 320	1 450	1 710	1 970	2 210	2 430					65
		1 090	1 220	1 360	1 500	1 770	2 040	2 280	2 510					50
980	1 120	1 260	1 400	1 540	1 820	2 090	2 350	2 580						40
1 060	1 210	1 370	1 520	1 670	1 970	2 270	2 550	2 800						30
1 530	1 750	1 970	2 190	2 400	2 840	3 270	3 670	4 030						10
				1 055	1 175	1 425	1 735	2 010	2 285	2 595	2 905	3 120	3 550	100
				1 090	1 220	1 475	1 800	2 090	2 385	2 700	3 015	3 240	3 710	80
				1 110	1 240	1 505	1 830	2 130	2 430	2 750	3 070	3 300	3 800	70
				1 180	1 320	1 595	1 945	2 250	2 560	2 905	3 255	3 490	3 975	50
				1 200	1 340	1 625	1 980	2 300	2 620	2 965	3 305	3 560	4 080	40
				1 670	1 865	2 255	2 740	3 170	3 600	4 055	4 505	4 875	5 600	10
		1 120	1 260	1 400	1 540	1 810	2 150	2 490	2 820	3 150				90
		1 210	1 360	1 510	1 670	1 970	2 340	2 700	3 060	3 420				65
		1 250	1 410	1 560	1 720	2 030	2 410	2 790	3 160	3 530				50
1 120	1 280	1 440	1 610	1 770	2 090	2 480	2 860	3 240	3 620					40
1 220	1 400	1 570	1 740	1 920	2 270	2 690	3 110	3 530	3 940					30
1 760	2 010	2 260	2 510	2 760	3 270	3 880	4 480	5 080	5 670					10
		1 120	1 260	1 400	1 540	1 810	2 150	2 490	2 820	3 150	3 650	4 250		90
		1 210	1 360	1 510	1 670	1 970	2 340	2 700	3 060	3 420	3 960	4 610		65
		1 250	1 410	1 560	1 720	2 030	2 410	2 790	3 160	3 530	4 090	4 760		50
1 120	1 280	1 440	1 610	1 770	2 090	2 480	2 860	3 240	3 620	4 200	4 890			40
1 220	1 400	1 570	1 740	1 920	2 270	2 690	3 110	3 530	3 940	4 560	5 310			30
1 760	2 010	2 260	2 510	2 760	3 270	3 880	4 480	5 080	5 670	6 570	7 650			10

Multipurpose radial tires

Technical data and load capacities

Tire size	Tread pattern Type	Service description LI/SS	Rims * (permitted)	Section width (mm)	Overall diameter (mm)	Loaded static radius (mm)	Rolling circumference (mm)
445/65 R 22.5 MPT	AC 70 + TL	160 G	14 13	450 440	1 172	536	3 525
405/70 R 24 MPT	AC 70 G TL	149 G	13	419	1 166	541	3 530
445/70 R 24 MPT	AC 70 G TL	151 G	W 13 W 14 L W 12	435 445 425	1 248	561	3 708
495/70 R 24 MPT	AC 70 G TL	155 G	W 15 L W 16 L W 14 L	493 503 483	1 313	582	3 908
495/70 R 30 MPT	AC 70 G TL	147 G	W 15 L W 16 L W 14 L	486 496 476	1 462	666	4 325

* Additional permitted rims may be available on request

Overloading of the tires is not permitted.

After 2 hours of driving on highways ¼ hour stop for cooling down of the tires.

Load values for 0.6 bar are for calculating dual and triple load values only.

30 km/h (up to 40 km/h) load values also apply for low-speed high-torque field work.

For plowing with single driven tires in the furrow, a minimum inflation pressure of 0.8 bar is required.

For intensive road transport at 90/65/50/40/30 km/h the pressure must be increased by 0.4 bar. Maximum inflation pressure should never be exceeded.

All load values are valid for ground slopes up to and including 20% (11°). When operating on slopes greater than 20%, please, contact the producer.

Tubeless tires – may be used with a tube.

AC 70 +



AC 70 G



												Speed (km/h)		
	0.8	1.0	1.2	1.4	1.6	2.0	2.5	3.0	3.5	4.0	4.5	5.0	6.0	
1 280	1 270	1 430	1 580	1 740	2 060	2 410	2 750	3 075	3 390	3 690	3 960	4 500	90	
	1 370	1 550	1 720	1 890	2 235	2 615	2 985	3 340	3 675	4 000	4 295	4 885	65	
	1 420	1 600	1 770	1 950	2 305	2 700	3 080	3 445	3 795	4 130	4 435	5 040	50	
	1 460	1 640	1 820	2 005	2 365	2 770	3 165	3 540	3 900	4 240	4 550	5 175	40	
	1 390	1 580	1 780	1 980	2 175	2 575	3 015	3 440	3 845	4 235	4 610	4 950	5 625	30
2 000	2 280	2 570	2 850	3 135	3 705	4 340	4 950	5 540	6 100	6 640	7 125	8 100	10	
1 060	1 050	1 180	1 320	1 450	1 710	2 030	2 340	2 650	2 950	3 250			90	
	1 140	1 290	1 430	1 570	1 860	2 200	2 540	2 870	3 200	3 530			65	
	1 180	1 330	1 470	1 620	1 920	2 270	2 620	2 960	3 300	3 640			50	
	1 210	1 360	1 510	1 670	1 970	2 330	2 690	3 040	3 390	3 740			40	
	1 150	1 320	1 480	1 650	1 810	2 140	2 530	2 920	3 310	3 690	4 060		30	
1 660	1 900	2 130	2 370	2 610	3 080	3 650	4 210	4 760	5 310	5 850		10		
1 230	1 220	1 370	1 520	1 670	1 980	2 440	2 930	3 450					90	
	1 320	1 490	1 650	1 820	2 150	2 650	3 180	3 740					65	
	1 370	1 540	1 710	1 880	2 220	2 740	3 290	3 860					50	
	1 400	1 580	1 750	1 930	2 280	2 810	3 370	3 970					40	
	1 330	1 520	1 710	1 900	2 090	2 480	3 050	3 670	4 310				30	
1 920	2 190	2 470	2 740	3 020	3 560	4 400	5 280	6 210				10		
1 450	1 440	1 620	1 800	1 980	2 340	2 840	3 250	3 875					90	
	1 560	1 760	1 950	2 150	2 540	3 080	3 630	4 210					65	
	1 620	1 810	2 020	2 220	2 620	3 180	3 750	4 340					50	
	1 660	1 860	2 070	2 280	2 690	3 260	3 850	4 460					40	
	1 570	1 800	2 020	2 250	2 470	2 920	3 550	4 190	4 850				30	
2 270	2 590	2 920	3 240	3 560	4 210	5 110	6 030	6 980				10		
1 600	1 590	1 790	1 990	2 180	2 580	3 075							90	
	1 720	1 940	2 160	2 370	2 800	3 340							65	
	1 780	2 000	2 220	2 450	2 890	3 450							50	
	1 830	2 060	2 280	2 510	2 970	3 540							40	
	1 740	1 990	2 230	2 480	2 730	3 230	3 850						30	
2 500	2 860	3 220	3 580	3 930	4 650	5 540						10		



Excellent traction

MPT-01



Tread pattern with very good traction and self-cleaning properties. Suitable above all for loader applications.



Excellent traction

TD-10



Lugged tread pattern for powered axle.



Excellent traction

TR-01 (R-4)



Excellent traction pattern, suitable for industrial and agricultural application.



Excellent traction

TI-05 (R-4)



Robust industrial tread pattern with excellent traction properties.

Agro-industrial diagonal tires

Robust and durable tires for various work

Tire size	MPT-01	TD-10	TR-01	TI-05
280/80-18	•			
275/80-18 MPT		•		
340/80-18	•			
320/80-18		•		
275/80-20 MPT		•		
335/80-20 MPT		•		
340/80-20	•			
360/80-20		•		
365/80-20 MPT		•		
400/70-20			•	
405/70-20	•			
15.5/80-24		•	•	
400/80-24 IND				•
405/70-24	•			
16.5/85-24		•		
17.5L-24			•	
460/70-24 IND			•	•
19.5L-24 IND				•
500/70-24 IND				•



Agro-industrial diagonal

Technical data and load capacities

Tire size	Tread pattern	Type	Rims * (permitted)	Tube Flap	Section width (mm)	Overall diameter (mm)	Loaded static radius (mm)	Rolling circumference (mm)
280/80-18 (10.5-18)	MPT-01	TL	9×18	10-18	270	905	419	2 660
280/80-18 (10.5-18)	MPT-01	TL	9×18	10-18	270	905	419	2 660
275/80-18 MPT (10.5-18 MPT)	TD-10	TL	9×18	–	278	911	422	2 730
340/80-18 (12.5-18)	MPT-01	TL	11×18 (9×18)	12.5-18 12-18HS	325	990	455	2 910
340/80-18 (12.5-18)	MPT-01	TL	11×18 (9×18)	12.5-18 12-18HS	325	990	455	2 910
340/80-18 (12.5-18)	MPT-01	TL	11×18 (9×18)	12.5-18 12-18HS	325	990	455	2 910
275/80-20 MPT (10.5-20 MPT)	TD-10	TL	9×20	–	278	948	444	2 805
275/80-20 MPT (10.5-20 MPT)	TD-10	TL	9×20	–	278	948	444	2 805
335/80-20 MPT (12.5-20 MPT)	TD-10	TL	11×20 11-20 SDC	–	340	1 044	480	3 055
340/80-20 (12.5-20)	MPT-01	TL	11×20 (11;12-20SDC)	–	325	1 040	480	3 060
340/80-20 (12.5-20)	MPT-01	TL	11×20 (11;12-20SDC)	–	325	1 040	480	3 060
365/80-20 MPT	TD-10	TL	11×20 11-20 SDC	–	360	1 092	503	3 215



MPT-01

TD-10

	Ply rating	Service description LI/SS	Tire load capacity (kg) at speed (km/h)						Tire pressure (bar)
			10	20	30	40	50	70	
10 PR	130 B	2 368	1 835	1 687	1 628	1 480		2.25	
		2 464	1 910	1 756	1 694	1 540		2.50	
		2 576	1 996	1 835	1 771	1 610		2.75	
		2 720	2 108	1 938	1 870	1 700		3.00	
		2 848	2 207	2 029	1 958	1 780		3.25	
		2 952	2 288	2 103	2 030	1 845		3.50	
		3 040	2 356	2 166	2 090	1 900		3.75	
16 PR	140 B	3 280	2 540	2 330	2 250	2 050		4.50	
		3 520	2 720	2 500	2 420	2 200		5.00	
		3 760	2 910	2 670	2 580	2 350		5.50	
		4 000	3 100	2 850	2 750	2 500		6.00	
10 PR	126 E	1 550	1 205	1 075	990	965		1.50	
		1 910	1 485	1 325	1 220	1 185	1 060	2.00	
		2 900	2 255	2 015	1 850	1 805	1 610	3.50	
		3 060	2 380	2 125	1 955	1 905	1 700	3.75	
10 PR	132 B	2 416	1 872	1 721	1 661	1 510		1.75	
		2 608	2 021	1 858	1 793	1 630		2.00	
		2 784	2 158	1 984	1 914	1 740		2.25	
		2 976	2 306	2 120	2 046	1 860		2.50	
		3 104	2 406	2 212	2 134	1 940		2.75	
		3 248	2 517	2 314	2 233	2 000		3.00	
12 PR	135 B	3 368	2 610	2 400	2 316	2 105		3.25	
		3 488	2 703	2 485	2 398	2 180		3.50	
16 PR	145 B	3 875	3 000	2 760	2 660	2 420		4.00	
		4 255	3 300	3 030	2 925	2 660		4.50	
		4 640	3 595	3 300	3 190	2 900		5.00	
8 PR	123 E	1 910	1 590	1 325	1 220	1 185	1 060	1.75	
		2 105	1 755	1 465	1 345	1 310	1 170	2.00	
		2 520	2 100	1 750	1 610	1 570	1 400	2.50	
		2 790	2 325	1 940	1 785	1 735	1 550	3.00	
12 PR	131 E	3 095	2 580	2 150	1 980	1 925	1 720	3.50	
		3 375	2 810	2 345	2 155	2 100	1 875	4.00	
		3 510	2 925	2 440	2 245	2 185	1 950	4.25	
10 PR	129 E	2 465	2 055	1 710	1 575	1 535	1 370	1.75	
		2 720	2 265	1 890	1 735	1 690	1 510	2.00	
		3 060	2 550	2 125	1 955	1 905	1 700	2.50	
		3 330	2 775	2 310	2 130	2 070	1 850	3.00	
10 PR	133 B	3 216	2 492	2 291	2 211	2 010		2.75	
		3 344	2 592	2 383	2 299	2 060		3.00	
12 PR	136 B	3 488	2 703	2 485	2 398	2 180		3.25	
		3 616	2 802	2 576	2 486	2 240		3.50	
10 PR	132 E	2 810	2 340	1 950	1 795	1 750	1 560	1.75	
		3 115	2 595	2 160	1 990	1 940	1 730	2.00	
		3 600	3 000	2 500	2 300	2 240	2 000	2.50	

Agro-industrial diagonal

Technical data and load capacities

Tire size	Tread pattern	Type	Rims * (permitted)	Tube Flap	Section width (mm)	Overall diameter (mm)	Loaded static radius (mm)	Rolling circumference (mm)
400/70-20	TR-01	TL	13×20 (13-20SDC)	–	404	1 090	490	3 210
405/70-20 (16/70-20)	MPT-01	TL	13×20 (13-20SDC)		407	1 076	495	3 165
405/70-20 (16/70-20)	MPT-01	TL	13×20 (13-20SDC)		407	1 076	495	3 165
15.5/80-24	TR-01	TL	W12×24 (W13×24) (W14L×24)	–	394	1 269	585	3 730
15.5/80-24	TR-01	TL	W12×24 (W13×24,W14L×24)	–	394	1 269	585	3 730
15.5/80-24	TR-01	TL	W12×24 (W13×24,W14L×24)	–	394	1 269	585	3 730
15.5/80-24	TR-01	TL	W12×24 (W13×24) (W14L×24)	–	394	1 269	585	3 730
405/70-24 (16/70-24)	MPT-01	TL	13×24 (13-24SDC)	16/70-24	407	1 178	545	3 465
17.5L-24	TR-01	TL	W15L×24	–	445	1 241	580	3 650

⁰⁾ Reinforced version also available (REINFORCED)



MPT-01

TR-01

	Ply rating	Service description LI/SS	Tire load capacity (kg) at speed (km/h)						Tire pressure (bar)
			10	20	30	40	50	70	
	14 PR	150 B	3 040	3 735	2 420	2 175	1 975	2.00	
3 580			3 225	2 850	2 560	2 325	2.50		
4 120			3 710	3 280	2 945	2 675	3.00		
4 660			4 195	3 710	3 330	3 025	3.50		
5 160			4 645	4 100	3 685	3 350	4.00		
	14 PR	149 B	3 840	2 976	2 736	2 640	2 400	2.25	
4 120			3 193	2 936	2 833	2 575	2.50		
4 656			3 608	3 317	3 201	2 910	3.00		
4 928			3 819	3 511	3 388	3 080	3.25		
5 200			4 030	3 705	3 575	3 250	3.50		
	16 PR	152 B	5 440	4 216	3 876	3 740	3 400	3.75	
5 680			4 402	4 047	3 905	3 550	4.00		
	12 PR	154/142 A8	3 025	2 720	2 400	2 160	1 945	2.00	
3 185			2 865	2 525	2 275	2 050	2.25		
3 305			2 975	2 650	2 360	2 125	2.50		
3 500			3 150	2 775	2 500	2 250	2.75		
3 710			3 340	2 900	2 650	2 385	3.00		
	14 PR⁽¹⁾	156/144 A8	3 815	3 435	3 025	2 725	2 455	3.25	
3 920			3 530	3 150	2 800	2 520	3.50		
	16 PR	159/147 A8	4 115	3 700	3 290	2 938	2 645	3.75	
4 305			3 875	3 445	3 075	2 770	4.10		
		163/151 A8	4 480	4 030	3 585	3 200	2 880	4.25	
4 655			4 190	3 725	3 325	2 995	4.50		
4 830			4 345	3 865	3 450	3 105	4.75		
	14 PR	152 B	5 360	4 154	3 819	3 685	3 350	3.75	
5 680			4 402	4 047	3 905	3 550	4.00		
	10 PR	- /144 A8	2 500	2 250	2 000	1 785	1 605	1.10	
2 800			2 520	2 240	2 000	1 800	1.30		
3 100			2 790	2 480	2 215	1 995	1.50		
3 400			3 060	2 720	2 430	2 185	1.70		
3 705			3 335	2 960	2 645	2 380	2.00		
3 920			3 530	3 135	2 800	2 520	2.20		

Agro-industrial diagonal

Technical data and load capacities

Tire size	Tread pattern Type	Rims (permitted)	New		Max. in service		Loaded static radius (mm)	Rolling circumference (mm)	
			Overall diameter (mm)	Section width (mm)	Overall diameter (mm)	Section width (mm)			
400/80 - 24 IND (15.5/80 - 24)	TI-05 TL	DW 13 × 24 (DW 14 L × 24) (13 × 24, 14 × 24) (TW 14 L × 24)	1 250	404	1 294	436	573	3 688	
460/70 - 24 IND (17.5L - 24)	TI-05 TL	DW 14 L × 24 (DW 15 L, DW 16 L, 14, 16, TW 14 L)	1 250	455	1 300	494	580	3 660	
460/70 - 24 IND (17.5L - 24)	TR-01 TL	DW 14 L × 24 (DW 15 L, DW 16 L, 14, 16, TW 14 L)	1 254	455	1 300	494	565	3 700	
19.5 L - 24 IND	TI-05 TL	DW 16 L × 24	1 314	495	1 356	535	610	3 865	
500/70 - 24 IND (19.5L - 24)	TI-05 TL	DW 16 L × 24 (DW 15 L × 24) (W 15 L × 24) (W 16 L × 24) (16 × 24)	1 310	503	1 360	528	589	3 865	

For Non-standard version, please contact a producer.

These tires are for normal agricultural use and not for continuous highway service.

TL = Tubeless



TR-01

TI-05

Service description LI/SS	Ply rating	Tire load capacity (kg) at speed (km/h)								Tire pressure (bar)
		Static	10	10 Cyclic	20	30	40	50		
162 A8	-	5 975	3 245	3 895	2 830	2 700	2 595	2 365	2.00	
		6 800	3 695	4 435	3 220	3 075	2 956	2 690	2.50	
		7 625	4 145	4 975	3 615	3 450	3 315	3 020	3.00	
		8 450	4 590	5 510	4 005	3 820	3 675	3 340	3.50	
		9 275	5 040	6 050	4 395	4 195	4 030	3 670	4.00	
		10 100	5 490	6 585	4 785	4 565	4 390	3 995	4.50	
		10 925	5 940	7 125	5 180	4 940	4 750	4 325	5.00	
159 A8	-	6 555	3 565	4 275	3 105	2 965	2 850	2 595	2.00	
		7 430	4 040	4 845	3 520	3 360	3 230	2 940	2.50	
		8 305	4 515	5 415	3 935	3 755	3 610	3 285	3.00	
		9 175	4 990	5 985	4 350	4 150	3 990	3 630	3.50	
		10 065	5 470	6 565	4 770	4 550	4 375	3 980	4.00	
159 A8	-	6 555	3 565	4 275	3 105	2 965	2 850	2 595	2.00	
		7 430	4 040	4 845	3 520	3 360	3 230	2 940	2.50	
		8 305	4 515	5 415	3 935	3 755	3 610	3 285	3.00	
		9 175	4 990	5 985	4 350	4 150	3 990	3 630	3.50	
		10 065	5 470	6 565	4 770	4 550	4 375	3 980	4.00	
151 A8	12 PR	4 510	2 450	2 940	2 140	2 040	1 960	1 785	1.10	
		5 095	2 770	3 325	2 415	2 305	2 215	2 015	1.30	
		5 680	3 090	3 705	2 690	2 570	2 470	2 250	1.50	
		6 270	3 405	4 090	2 970	2 835	2 725	2 480	1.70	
		7 075	3 845	4 615	3 350	3 200	3 075	2 800	1.90	
		7 510	4 080	4 900	3 560	3 395	3 265	2 970	2.10	
		7 935	4 315	5 175	3 760	3 590	3 450	3 140	2.30	
164 A8	-	7 705	4 185	5 022	3 650	3 485	3 350	3 050	2.00	
		8 650	4 700	5 640	4 100	3 910	3 760	3 425	2.50	
		9 600	5 220	6 260	4 550	4 340	4 175	3 800	3.00	
		10 550	5 735	6 880	5 000	4 770	4 585	4 175	3.50	
				11 500	6 250	7 500	5 450	5 200	5 000	4 550

Agro-industrial diagonal (TD-10)

Technical data and load capacities

Tire size	Tread pattern Type	Tube Flap	Rim * (permitted)	Section width (mm)	Overall diameter (mm)	Loaded static radius (mm)	Rolling circumference (mm)
320/80 - 18 (repl. 12.5/80 - 18)	TD-10 TL	12.5/14.5/80 - 18 T 38G16 S	9 × 18	308	1 000	430 ⊕ 443 ⊕	3 015 ⊕ 3 025 ⊕
360/80 - 20 (repl. 14.5/75 - 20)	TD-10 TL	16/70 - 20; 335/80 - 20; 375/405/70 - 20 47GW S	11 × 20 12 × 20	360 370	1 092	485 ⊕ 492 ⊕	3 200 ⊕ 3 205 ⊕
15.5/80 - 24	TD-10 TL	14.9/16.9(13/14) - 24 T 47GW S	W 13 W 14 W 12	376 387 365	1 270	575 ⊕ 586 ⊕	3 820 ⊕ 3 841 ⊕
16.5/85 - 24	TD-10 TL	14.9/16.9(13/14) - 24 T 47GW S	W 13 W 15 L W 14 L	413 435 424	1 338	580 ⊕ 590 ⊕	4 010 ⊕ 4 032 ⊕

For Non-standard version, please contact a producer.
These tires are for normal agricultural use and not for continuous highway service.

TL = Tubeless
TT = Tube Type
⊕ = drive wheel
⊕+ = free rolling wheel



	Service description		Tire load capacity (kg) at tire pressure (bar)									Speed (km/h)	
	PR	LI/SS	1.0	1.5	1.8	2.0	2.3	2.5	2.8	3.1	3.4		3.9
10 PR	139 A8 ⊕→	1 290	1 700	1 900	2 060	2 145	2 200	2 315	2 430				40
	126 A8 ⊕	900	1 185	1 330	1 440	1 500	1 540	1 570	1 700				40
8 PR	141 A8 ⊕→	1 630	2 135	2 290	2 330	2 575							40
	128 A8 ⊕	1 140	1 480	1 600	1 630	1 800							40
16 PR	164 A6 ⊕→	2 725	2 990	3 120	3 250	3 500	3 750	4 000	4 125	4 350	5 000		30
	152 A6 ⊕	1 900	2 100	2 200	2 300	2 475	2 650	2 800	2 900	3 160	3 550		30
14 PR	165 A6 ⊕→	2 400	3 150	3 600	3 750	3 955	4 090	4 420	4 750	5 150			30
	153 A6 ⊕	1 700	2 225	2 540	2 650	2 800	2 900	3 135	3 370	3 650			30



AF-01

RESISTANCE	● ● ● ● ●
TRACTION	● ● ● ● ●
SELF-CLEANING	● ● ● ● ●



TL-01

RESISTANCE	● ● ● ● ●
TRACTION	● ● ● ● ●
SELF-CLEANING	● ● ● ● ●

AF-01 and TL-01

Heavy-duty agroforestry tractor tires for the toughest conditions

High resistance to puncture due to reinforced construction and durable tread compound.

Great traction due to specially developed tread pattern.

Very good self-cleaning properties for better grip and less slip.

High load capability and transport properties.

Suitable for a wide range of uses in forestry and for heavy agricultural work.



Agro-forestry tires AF-01, TL-01

Technical data and load capacities

Tire size	Service description L/SS	Tread pattern Type	Rims * (permitted)	Tube	Section width (mm)	Overall diameter (mm)	Loaded static radius (mm)	Rolling circumference (mm)	Speed radius index	Water 75% (l)
380/85 - 24 (14.9 - 24)	137 A8 (134 B)	AF-01 TT	W 13 W 11 W 12	14.9 - 24	377 357 367	1 244	565	3 748	600	150
380/85 - 28 (14.9 - 28)	139 A8 (136 B)	AF-01 TT	W 13 W 11 W 12	14.9 - 28	386 366 376	1 354	612	4 056	650	190
16.9 - 30	12 PR	TL-01 TT	W 15 L W 14 L	16.9 - 30	429	1 485	685	4 390	700	240
420/85 - 34 (16.9 - 34)	147 A8 (144 B)	AF-01 TT	W 13 W 14 L W 15 L	16.9 - 34	425 435 445	1 582	719	4 730	750	265
460/85 - 34 (18.4 - 34)	152 A8 (149 B)	AF-01 TT	W 15 L W 14 L W 16 L	18.4 - 34	443 433 453	1 643	749	4 930	775	350

* Additional permitted rims may be available on request

For intensive road transport at 80/65/50/40/30 km/h the pressure must be increased by 0.4 bar. Maximum inflation pressure should never be exceeded.

All load values are valid for ground slopes up to and including 20% (11°). When operating on slopes greater than 20%, please, contact the producer.

TT = Tube Type



AF-01

TL-01

	Tire load capacity (kg) at tire pressure (bar)							Speed (km/h)
	1.0	1.2	1.3	1.8	2.0	2.4	2.8	
1 285	1 450	1 750	1 850	1 945	2 120			50
1 425	1 600	1 950	2 050	2 140	2 300			40
1 525	1 710	2 085	2 195	2 290	2 460			30
1 875	2 085	2 505	2 715	2 925	3 170		3 370	10
1 385	1 550	1 900	2 005	2 095	2 240			50
1 510	1 700	2 060	2 170	2 270	2 430			40
1 615	1 820	2 205	2 325	2 430	2 600			30
1 980	2 210	2 655	2 875	3 000	3 360		3 585	10
1 310	1 525	1 850	1 960	2 070	2 180			40
1 635	1 905	2 315	2 450	2 585	2 725			30
1 960	2 290	2 780	2 940	3 105	3 270			20
2 290	2 670	3 240	3 430	3 625	3 815		4 060	10
1 775	2 000	2 430	2 550	2 650	2 800			50
1 940	2 180	2 650	2 785	2 900	3 075			40
2 075	2 335	2 835	2 980	3 100	3 290			30
2 550	2 840	3 410	3 695	3 975	4 300		4 555	10
2 020	2 300	2 800	2 940	3 060	3 250			50
2 225	2 500	3 075	3 225	3 355	3 550			40
2 380	2 675	3 290	3 450	3 590	3 800			30
2 925	3 255	3 925	4 265	4 615	4 980		5 270	10



TD-01

Durable traction pattern, also suitable for industrial use.



TD-02

Universal tread pattern with excellent traction for a wide range of applications.



TD-05

Unique tread pattern with 23 degree inclined blocks for better traction and self-cleaning properties. The reinforced shoulder prevents side-slipping and helps overall tire strength.



TD-08

Lugged tread pattern for powered axle.



TD-13

A classic design for tractors, well-tested and proven.



TD-17

Pattern featuring increased tread lug depth giving better traction and less slip in difficult conditions.



TD-19

Traction tread pattern with larger rib surface in the central part.

TD series – Tractor diagonal tires

For tractors and other self-propelled agricultural machinery



TD series

Technical data and load capacities

Tire size	Tread pattern	Type	Rim (permitted)	Tube	Section width (mm)	Overall diameter (mm)	Loaded static radius (mm)	Rolling circumference (mm)	
8.3-20	TD-13	TT	W7 (W6)	8.3-20	211	895	416	2 640	
8.3-24	TD-02	TT	W7 (W6)	8.3-24/9.5-24	211	995	470	2 935	
9.5-24	TD-02	TT	W8 (W7)	8.3-24/9.5-24	241	1 050	495	3 095	
11.2-24	TD-02	TT	W10 (W9)	11.2-24	284	1 105	520	3 300	
11.2-24	TD-19	TT	W10 (W9)	11.2-24	284	1 105	520	3 300	
11.2-24	TD-19	TL	W10 (W9)	(11.2-24)	284	1 105	520	3 300	
12.4-24	TD-02	TT	W11 (W9, W10)	12.4-24	315	1 160	539	3 473	
12.4-24	TD-19	TT	W11 (W9, W10)	12.4-24	315	1 160	539	3 473	
12.4-24	TD-19	TL	W11 (W9, W10)	(12.4-24)	315	1 160	539	3 473	
13.6-24	TD-19	TT	W11 (W12)	13.6-24	335	1 210	555	3 580	
14.9-24	TD-08	TL	W13 (W11, W12)	14.9-24	393	1 252	562	3 618	
14.9-24	TD-19	TT	W13 (W11, W12)	14.9-24	378	1 265	581	3 795	



	Ply rating PR	Service description LI/SS	Tire load capacity (kg) at speed (km/h)				Tire pressure (bar)
			10	20	30	40	
	6 PR	104 / 92 A8	530	465	410	370	0.8
			660	580	510	460	1.2
			785	695	610	550	1.6
			915	810	710	630	2.0
	6 PR	100 A6 (93 A8)	855	730	610	490	1.5
			940	800	670	540	1.8
			1 030	880	735	590	2.1
			1 120	960	800	650	2.4
	8 PR	112 A6 (104 A8)	1 220	1 045	870	700	1.8
			1 330	1 140	950	760	2.1
			1 465	1 255	1 045	840	2.5
			1 570	1 345	1 120	900	2.8
	8 PR	116 A6 (108 A8)	1 330	1 140	950	760	1.5
			1 485	1 270	1 060	850	1.8
			1 620	1 385	1 155	925	2.1
			1 750	1 500	1 250	1 000	2.4
	8 PR	116 A6 (108 A8)	1 330	1 140	950	760	1.5
			1 485	1 270	1 060	850	1.8
			1 620	1 385	1 155	925	2.1
			1 750	1 500	1 250	1 000	2.4
	10 PR	119 A8	1 970	1 450	1 400	1 310	2.8
			2 040	1 510	1 460	1 360	3.0
	8 PR	120 A6 (112 A8)	1 580	1 355	1 130	905	1.5
			1 700	1 460	1 215	970	1.7
			1 835	1 570	1 310	1 050	2.0
			1 960	1 680	1 400	1 120	2.3
	8 PR	120 A6 (112 A8)	1 580	1 355	1 130	905	1.5
			1 700	1 460	1 215	970	1.7
			1 835	1 570	1 310	1 050	2.0
			1 960	1 680	1 400	1 120	2.3
	12 PR	128 A8	2 420	1 790	1 720	1 610	2.9
			2 520	1 860	1 800	1 680	3.1
			2 610	1 930	1 860	1 740	3.3
			2 700	2 000	1 930	1 800	3.5
	8 PR	123 A6 (116 A8)	1 975	1 695	1 410	1 130	1.4
			2 085	1 790	1 490	1 190	1.7
			2 170	1 860	1 550	1 250	2.0
	4 PR	112 A6 (104 A8)	1 330	1 140	950	750	0.6
			1 570	1 345	1 120	900	0.8
	8 PR	128 A6 (121 A8)	1 990	1 705	1 420	1 135	1.2
			2 170	1 860	1 550	1 250	1.4
			2 345	2 010	1 675	1 340	1.6
			2 520	2 160	1 800	1 450	1.8

TD series

Technical data and load capacities

Tire size	Tread pattern	Type	Rim (permitted)	Tube	Section width (mm)	Overall diameter (mm)	Loaded static radius (mm)	Rolling circumference (mm)
16.9-24	TD-13	TT	W15L (W14L)	16.9-24	429	1 335	620	3 940
18.4-26	TD-19	TL	W16L(W15L)	(18.4-26)	467	1 450	663	4 285
23.1-26	TD-01	TL	DW20	(23.1-26)	587	1 605	760	4 720
11.2-28	TD-02	TT	W10 (W9)	11.2-28	284	1 205	565	3 555
12.4-28	TD-02	TT	W11 (W10)	12.4-28	315	1 260	598	3 750
12.4-28	TD-19	TT	W11 (W10)	12.4-28	315	1 260	598	3 750
12.4-28	TD-19	TT	W11 (W10)	12.4-28	315	1 260	598	3 750
13.6-28	TD-19	TT	W12 (W11)	13.6-28	345	1 310	612	3 853
14.9-28	TD-19	TT	W13 (W12)	14.9-28	378	1 365	627	4 113
16.9-28	TD-13	TT	W15L (W14L)	16.9-28	429	1 435	670	4 235
16.9-28	TD-13	TT	W15L (W14L)	16.9-28	429	1 435	670	4 235



	Ply rating PR	Service description LI/SS	Tire load capacity (kg) at speed (km/h)				Tire pressure (bar)
			10	20	30	40	
	8 PR	133 A6 (125 A8)	2 240	1 920	1 600	1 280	1.1
2 450			2 100	1 750	1 400	1.3	
2 665			2 285	1 905	1 525	1.5	
2 885			2 470	2 060	1 650	1.7	
	12 PR	156 A8	4 785	3 470	3 380	3 190	1.9
5 430			3 940	3 830	3 620	2.2	
6 000			4 360	4 160	4 000	2.5	
	14 PR	156 A8	4 350	3 565	3 100	2 900	1.1
4 875			4 000	3 480	3 250	1.4	
5 475			4 490	3 905	3 650	1.7	
6 000			4 920	4 280	4 000	2.0	
	8 PR	118 A6 (110 A8)	1 260	1 080	900	720	1.3
1 415			1 210	1 010	810	1.5	
1 570			1 345	1 120	900	1.8	
1 710			1 465	1 220	975	2.1	
1 850			1 585	1 320	1 060	2.4	
	8 PR	123 A6 (116 A8)	1 445	1 235	1 030	825	1.1
1 620			1 385	1 155	925	1.4	
1 800			1 540	1 285	1 030	1.7	
2 005			1 715	1 430	1 145	2.0	
2 170			1 860	1 550	1 250	2.3	
	6 PR	117 A6 (109 A8)	1 445	1 235	1 030	825	1.1
1 620			1 385	1 155	925	1.4	
1 800			1 540	1 285	1 030	1.7	
	10 PR	128 A6 (121 A8)	2 005	1 715	1 430	1 145	2.0
2 170			1 860	1 550	1 250	2.3	
2 335			2 000	1 650	1 335	2.5	
2 535			2 175	1 790	1 450	2.8	
	6 PR	121 A6 (113 A8)	1 570	1 345	1 120	895	1.0
1 720			1 475	1 230	985	1.2	
1 875			1 610	1 340	1 070	1.4	
2 030			1 740	1 450	1 150	1.6	
	8 PR	130 A6 (122 A8)	1 905	1 630	1 360	1 090	1.0
2 115			1 810	1 510	1 210	1.2	
2 395			2 050	1 710	1 370	1.5	
2 660			2 280	1 900	1 500	1.8	
	8 PR	135 A6 (127 A8)	2 355	2 015	1 680	1 345	1.1
2 730			2 340	1 950	1 560	1.4	
3 055			2 615	2 180	1 750	1.7	
	12 PR	143 A6 (135 A8)	3 305	2 830	2 360	1 890	1.9
3 400			2 915	2 430	1 950	2.0	
3 605			3 090	2 575	2 060	2.2	
3 815			3 310	2 725	2 180	2.4	

TD series

Technical data and load capacities

Tire size	Tread pattern	Type	Rim (permitted)	Tube	Section width (mm)	Overall diameter (mm)	Loaded static radius (mm)	Rolling circumference (mm)
16.9-30	TD-13	TT	W15L (W14L)	16.9-30	429	1 485	685	4 390
16.9-30	TD-13	TT	W15L (W14L)	16.9-30	429	1 485	685	4 390
16.9-30	TD-17	TT	W15L (W14L)	16.9-30	429	1 485	685	4 390
18.4-30	TD-13	TT	W16L (W15L)	16.9-30	467	1 550	714	4 540
18.4-30	TD-13	TT	W16L (W15L)	16.9-30	467	1 550	714	4 540
16.9-34	TD-02	TT	W15L (W14L)	16.9-34	429	1 585	724	4 680
16.9-34	TD-17	TT	W15L (W14L)	16.9-34	429	1 585	724	4 680
18.4-34	TD-02	TT	W16L (W15L)	16.9-34 18.4-34	467	1 650	770	4 865
18.4-34	TD-19	TT	W16L (W15L)	16.9-34 18.4-34	467	1 650	770	4 865
18.4-34	TD-19	TT	W16L (W15L)	16.9-34 18.4-34	467	1 650	770	4 865
12.4-36	TD-13	TT	W11 (W10)	12.4-36	315	1 465	685	4 330



	Ply rating PR	Service description LI/SS	Tire load capacity (kg) at speed (km/h)				Tire pressure (bar)
			10	20	30	40	
	10 PR	140 A6 (132 A8)	2 410	2 065	1 720	1 375	1.1
2 885			2 470	2 060	1 650	1.4	
3 220			2 760	2 300	1 850	1.7	
3 500			3 000	2 500	2 000	2.0	
	12 PR	143 A6 (135 A8)	3 815	3 270	2 725	2 180	2.3
	10 PR	140 A6 (132 A8)	2 410	2 065	1 720	1 375	1.1
2 885			2 470	2 060	1 650	1.4	
3 220			2 760	2 300	1 850	1.7	
3 500			3 000	2 500	2 000	2.0	
	12 PR	149 A6 (141 A8)	2 645	2 270	1 890	1 515	0.9
3 110			2 665	2 220	1 775	1.2	
3 400			2 915	2 430	1 950	1.4	
4 355			3 730	3 110	2 490	2.1	
4 550			3 900	3 250	2 575	2.3	
	14 PR	152 A6 (144 A8)	4 745	4 070	3 390	2 710	2.5
			4 970	4 260	3 550	2 800	2.7
	10 PR	142 A6 (134 A8)	2 620	2 245	1 870	1 495	1.1
3 010			2 580	2 150	1 720	1.4	
3 400			2 915	2 430	1 950	1.7	
3 710			3 180	2 650	2 120	2.0	
	8 PR	139 A6 (131 A8)	2 620	2 245	1 870	1 495	1.1
3 010			2 580	2 150	1 720	1.4	
3 400			2 915	2 430	1 950	1.7	
	12 PR	151 A6 (144 A8)	3 050	2 615	2 180	1 745	1.0
3 380			2 900	2 415	1 930	1.2	
3 710			3 180	2 650	2 120	1.4	
3 955			3 390	2 825	2 260	1.6	
4 200			3 600	3 000	2 430	1.8	
4 580			3 925	3 270	2 620	2.1	
4 830			4 140	3 450	2 800	2.3	
	8 PR	142 A6 (134 A8)	3 050	2 615	2 180	1 745	1.0
3 380			2 900	2 415	1 930	1.2	
3 710			3 180	2 650	2 120	1.4	
	12 PR	151 A6 (144 A8)	4 580	3 925	3 270	2 620	2.1
4 830			4 140	3 450	2 800	2.3	
	12 PR	135 A6 (127 A8)	1 610	1 380	1 150	920	1.1
1 750			1 500	1 250	1 000	1.3	
1 890			1 620	1 350	1 080	1.5	
2 030			1 740	1 450	1 150	1.7	
2 610			2 240	1 865	1 490	2.7	
2 750			2 360	1 965	1 570	2.9	
2 900			2 485	2 070	1 655	3.1	
3 050			2 615	2 180	1 750	3.3	

TD series

Technical data and load capacities

Tire size	Tread pattern	Type	Rim (permitted)	Tube	Section width (mm)	Overall diameter (mm)	Loaded static radius (mm)	Rolling circumference (mm)
13.6-36	TD-13	TT	W12 (W11)	13.6-36	345	1 515	698	4 447
11.2-38	TD-13	TL	W10 (W9)	11.2-38	290	1 454	665	4 380
12.4-38	TD-17	TT	W11 (W10)	12.4-38	320	1 515	719	4 514
13.6-38	TD-13	TT	W12 (W11)	13.6-38	345	1 565	740	4 670
13.6-38	TD-13	TT	W12 (W11)	13.6-38	345	1 565	740	4 670
14.9-38	TD-05	TT	W13 (W12)	14.9-38	380	1 640	760	4 838
15.5-38	TD-05	TT	W14L	15.5-38	394	1 580	745	4 661
16.9-38	TD-19	TT	W15L (W14L)	16.9-38	429	1 685	795	5 091
16.9-38	TD-13	TT	W15L (W14L)	16.9-38	429	1 685	795	5 091
18.4-38	TD-19	TT	W16L (W15L)	18.4-38	467	1 750	814	5 216

The inflation pressure must be increased for front-end loader tractor application +0.4 bar.

For Non-standard version, please contact a producer.

These tires are for normal agricultural use and not for continuous highway service.

TL = Tubeless

TT = Tube Type



	Ply rating PR	Service description LI/SS	Tire load capacity (kg) at speed (km/h)				Tire pressure (bar)
			10	20	30	40	
6 PR	125 A6 (118 A8)	1 625	1 390	1 160	930	0.9	
		1 895	1 625	1 355	1 085	1.2	
		2 080	1 780	1 485	1 190	1.4	
		2 310	1 980	1 650	1 320	1.6	
4 PR	106 A8	980	840	700	630	0.8	
		1 225	1 050	875	800	1.0	
		1 330	1 140	950	850	1.1	
		1 465	1 255	1 045	950	1.3	
8 PR	127 A6 (120 A8)	2 070	1 775	1 480	1 185	1.7	
		2 200	1 885	1 570	1 255	1.9	
		2 325	1 990	1 660	1 330	2.1	
		2 450	2 100	1 750	1 400	2.3	
6 PR	126 A6 (119 A8)	1 695	1 450	1 210	970	0.9	
		2 015	1 730	1 440	1 150	1.2	
		2 200	1 885	1 570	1 255	1.4	
		2 380	2 040	1 700	1 360	1.6	
14 PR	139 A6 (131 A8)	2 920	2 500	2 085	1 670	2.9	
		3 075	2 635	2 195	1 755	3.1	
		3 235	2 770	2 310	1 850	3.3	
		3 400	2 915	2 430	1 950	3.5	
6 PR	129 A6 (122 A8)	2 190	1 880	1 565	1 250	1.0	
		2 380	2 040	1 700	1 360	1.2	
		2 590	2 220	1 850	1 480	1.4	
8 PR	133 A6 (125 A8)	2 470	2 120	1 765	1 400	1.4	
		2 655	2 275	1 895	1 520	1.6	
		2 885	2 475	2 060	1 650	1.8	
8 PR	141 A6 (133 A8)	2 620	2 245	1 870	1 495	1.0	
		3 050	2 615	2 180	1 745	1.3	
		3 325	2 850	2 375	1 900	1.5	
		3 605	3 090	2 575	2 060	1.7	
8 PR	141 A6 (133 A8)	2 620	2 245	1 870	1 495	1.0	
		3 050	2 615	2 180	1 745	1.3	
		3 325	2 850	2 375	1 900	1.5	
		3 605	3 090	2 575	2 060	1.7	
8 PR	143 A6 (135 A8)	3 025	2 590	2 160	1 730	0.9	
		3 485	2 990	2 490	1 990	1.2	
		3 815	3 270	2 725	2 180	1.4	



IM-01

Tested and proven tread pattern for transportation, also suitable for powered wheels.



IM-02

Tread pattern with excellent traction for a wide range of applications.



IM-03

A classic implement design for universal use.



IM-04

Modern universal tread pattern suitable for a wide range of agricultural uses.



IM-07

Pattern with rolling rib profile without any lateral tread elements. Suitable for meadowland use or soil cultivation.



IM-09

Traction pattern with strong side lugs. Low inflation pressure for reduced soil compaction.



IM-10

Ribbed pattern without any lateral tread elements. Suitable for soil cultivation and for light transport applications.



AC 30

Robust tread pattern for construction vehicles.

IM series – Implement diagonal

Great transportation properties



B 3

Specially designed for garden tractors, large mowers and municipal tractors.



G 1

Perfect tread pattern for small machines and tools as lawn mowers.



B 19

Ribbed tread pattern with rounded shoulder. Good stability and self-cleaning properties. Ideal for small horticultural and hay making machinery.



B 63

Special tread pattern with good stability, lawn protection and comfort.



IM series

Technical data and load capacities

Tire size	Tread pattern	Type	Rim (permitted)	Tube	Section width (mm)	Overall diameter (mm)	Loaded static radius (mm)	Rolling circumference (mm)	
13 × 5.00 - 6	G 1	TL	3.50 × 6	4.00 - 6	124	322	148	963	
13 × 5.00 - 6	B 19	TL	3.50 × 6	4.00 - 6	124	322	148	963	
13 × 5.00 - 6	B 19	TL	3.50 × 6	4.00 - 6	124	322	148	963	
15 × 6.00 - 6	B 19	TL	4.50 × 6	15 × 6.00 - 6	150	362	165	1 082	
16 × 6.50 - 8	B 19	TL	5.375 × 8	16 × 6.50/7.50 - 8	165	408	189	1 220	
16 × 6.50 - 8	B 19	TL	5.375 × 8	16 × 6.50/7.50 - 8	165	408	189	1 220	
16 × 6.50 - 8	B 19	TL	5.375 × 8	16 × 6.50/7.50 - 8	165	408	189	1 220	
18 × 8.50 - 8	G 1	TL	7.00 × 8	18 × 8.50/9.50 - 8	214	462	212	1 381	
18.5 × 8.50 - 8 (215/65 - 8)	B 63	TL	7.00 × 8	18 × 8.50/9.50 - 8	215	470	211	1 375	
18.5 × 8.50 - 8 (215/65 - 8)	B 63	TL	7.00 × 8	18 × 8.50/9.50 - 8	215	470	211	1 375	
10.0/80 - 12	IM - 04	TL	9.00 × 12 (7.00 × 12)	10.0/80 - 12	264	710	316	2 085	
10.0/80 - 12	IM - 04	TL	9.00 × 12 (7.00 × 12)	10.0/80 - 12	264	710	316	2 085	
200/60 - 14.5	IM - 10	TL	6.75 × 14.5		200	620	285	1 823	
28 × 9.00 - 15	AC 30	TT	7.00 I × 15 6 1/2 K × 15	43GS16	234 229	710	322	2 160	
240/70 - 15	B 3	TL	7.00 I × 15 6 1/2 K × 15		232 227	721	322	2 135	



	Ply rating PR	Service description LI/SS	Tire load capacity (kg) at speed (km/h)					Tire pressure (bar)
			10	20	30	40	50	
	4 PR	49 A4	211	185				2.25
	4 PR	49 A4	211	185				2.25
	8 PR	66 A4	342	300				4.25
	6 PR	72 A4	405	355				3.00
	6 PR	70 A4	382	335				3.00
	10 PR	77 A4	470	412				3.75
	12 PR	80 A4	513	450				4.00
	6 PR	78 A4	485	425				2.75
	6 PR	78 A6	548	485	425			3.50
	12 PR	90 A6	774	684	600			6.30
			1 175	1 060	940	840	755	1.75
			1 225	1 105	980	875	790	2.00
			1 330	1 200	1 065	950	855	2.30
			1 360	1 220	1 085	970	875	2.50
			1 450	1 305	1 160	1 035	930	2.75
	8 PR	112 A8	1 570	1 410	1 255	1 120	1 010	3.10
			1 650	1 485	1 320	1 180	1 060	3.40
			1 745	1 570	1 395	1 245	1 120	3.70
	10 PR	117 A8	1 800	1 620	1 440	1 285	1 155	3.90
			600	540	480	430	390	1.50
			720	650	575	515	465	2.00
			805	725	645	575	520	2.50
			880	795	705	630	565	3.00
			960	865	765	685	615	3.50
			1 035	930	830	740	665	4.00
			1 115	1 000	890	795	715	4.50
	10 PR	102 A8	1 190	1 070	950	850	765	5.00
					(25 km/h)			
			455	435	425			0.70
			510	495	480			0.90
			545	525	510			1.00
			695	670	650			1.50
			810	780	760			2.00
	6 PR	102 A5	905	875	850			2.50
			1 210	640	580	510		1.00
			1 660	895	790	710	640	1.60
			1 810	970	860	770	690	2.00
			2 500	1 350	1 190	1 070	960	3.00
			2 770	1 485	1 320	1 180	1 060	3.50
	8 PR	115 A8	2 860	1 530	1 360	1 215	1 090	4.00

IM series

Technical data and load capacities

Tire size	Tread pattern	Type	Rim (permitted)	Tube	Section width (mm)	Overall diameter (mm)	Loaded static radius (mm)	Rolling circumference (mm)
10.0/75 - 15.3	IM-04	TL	9.00×15.3	10 - 15 HS 10/75 - 15	264	760	351	2 235
10.0/75 - 15.3	IM-04	TL	9.00×15.3	10 - 15 HS 10/75 - 15	264	760	351	2 235
10.0/75 - 15.3	IM-04	TL	9.00×15.3	10 - 15 HS 10/75 - 15	264	760	351	2 235
10.0/75 - 15.3	IM-04	TL	9.00×15.3	10 - 15 HS 10/75 - 15	264	760	351	2 235
11.5/80 - 15.3	IM-04	TL	9.00×15.3	11.5/80 - 15	290	845	386	2 485
11.5/80 - 15.3	IM-04	TL	9.00×15.3	11.5/80 - 15	290	845	386	2 485
11.5/80 - 15.3	IM-04	TL	9.00×15.3	11.5/80 - 15	290	845	386	2 485
11.5/80 - 15.3	IM-04	TL	9.00×15.3	11.5/80 - 15	290	845	386	2 485
12.5/80 - 15.3	IM-04	TL	9.00×15.3	–	307	889	436	2 615
400/60 - 15.5	IM-07	TL	13.00×15.5	–	405	875	380	2 575
400/60 - 15.5	IM-07	TL	13.00×15.5	–	405	875	380	2 575
400/60 - 15.5	IM-07	TL	13.00×15.5	–	405	875	380	2 575
10.50 - 16	IM-01	TT	7.00I - 16 (7.0 - 401.5)	10.50 - 16	274	945	432	2 780



	Ply rating PR	Service description LI/SS	Tire load capacity (kg) at speed (km/h)					Tire pressure (bar)
			10	20	30	40	50	
10 PR	122 A8	1 665	1 500	1 335	1 190	1 070	2.50	
		1 850	1 665	1 480	1 320	1 190	3.00	
		1 975	1 775	1 580	1 410	1 270	3.50	
		2 100	1 890	1 680	1 500	1 350	4.00	
12 PR	125 A8	2 240	2 015	1 790	1 600	1 440	4.50	
		2 310	2 080	1 850	1 650	1 485	4.75	
14 PR ⁽¹⁾	130 A8	2 430	2 185	1 945	1 735	1 560	5.00	
		2 660	2 395	2 130	1 900	1 710	5.50	
18 PR ⁽¹⁾	143 A8	3 025	2 720	2 420	2 160	1 945	6.00	
		3 380	3 045	2 705	2 415	2 175	6.50	
		3 815	3 435	3 050	2 725	2 455	7.10	
10 PR	130 A8	2 065	1 860	1 650	1 475	1 330	2.50	
		2 430	2 185	1 945	1 735	1 565	3.00	
		2 660	2 395	2 130	1 900	1 710	3.50	
12 PR	134 A8	2 815	2 535	2 250	2 010	1 810	3.75	
		2 970	2 670	2 375	2 120	1 910	4.00	
14 PR	139 A8	3 260	2 935	2 610	2 330	2 095	4.50	
		3 400	3 060	2 720	2 430	2 185	4.75	
16 PR ⁽²⁾	141 A8	3 470	3 125	2 780	2 480	2 230	5.00	
		3 605	3 245	2 885	2 575	2 320	5.40	
14 PR	141 A8	2 920	2 625	2 335	2 085	1 875	3.25	
		3 110	2 795	2 485	2 220	2 000	3.50	
		3 305	2 975	2 645	2 360	2 125	3.70	
		3 485	3 135	2 790	2 490	2 240	4.00	
		3 605	3 245	2 885	2 575	2 320	4.30	
14 PR	140 A8	2 015	1 815	1 615	1 440	1 295	1.25	
		2 185	1 965	1 745	1 560	1 405	1.50	
		2 520	2 270	2 015	1 800	1 620	2.00	
		2 800	2 520	2 240	2 000	1 800	2.50	
		3 150	2 835	2 520	2 250	2 025	3.00	
		3 500	3 150	2 800	2 500	2 250	3.50	
		145 A8	4 060	3 650	3 250	2 900	2 610	3.60
152 A8	4 410	3 970	3 530	3 150	2 835	4.00		
	4 690	4 220	3 750	3 350	3 015	5.00		
	4 970	4 475	3 975	3 550	3 195	6.00		
14 PR	144 A8	2 870	2 585	2 295	2 050	1 845	3.25	
		2 970	2 670	2 375	2 120	1 910	3.50	
		3 220	2 900	2 575	2 300	2 070	4.00	
		3 470	3 125	2 780	2 480	2 230	4.50	
		3 710	3 340	2 970	2 650	2 385	5.00	
		3 920	3 530	3 135	2 800	2 520	5.25	

⁽¹⁾ Reinforced version also available (REINFORCED)

⁽²⁾ Reinforced version for TT type also available (REINFORCED)

IM series

Technical data and load capacities

Tire size	Tread pattern	Type	Rim (permitted)	Tube	Section width (mm)	Overall diameter (mm)	Loaded static radius (mm)	Rolling circumference (mm)
15.0/55 - 17	IM-04	TL	13.00×17 (13×17)	15.0/55 - 17	391	850	410	2 499
15.0/55 - 17	IM-04	TL	13.00×17	15.0/55 - 17	391	850	410	2 499
19.0/45 - 17	IM-04	TL	16.00×17	–	491	866	390	2 546
19.0/45 - 17	IM-04	TL	16.00×17	–	491	866	390	2 546
500/50 - 17	IM-07	TL	16.00×17	–	500	940	420	2 763
500/50 - 17	IM-07	TL	16.00×17	–	500	940	420	2 763
12.5/80 - 18	IM-03	TT	11×18 (9×18)	12 - 18 HS 12.5 - 18	308	965	444	2 840
12.5/80 - 18	IM-03	TT	11×18 (9×18)	12 - 18 HS 12.5 - 18	308	965	444	2 840
12.5/80 - 18	IM-04	TT	11×18 (9×18)	12 - 18 HS 12.5 - 18	308	965	444	2 840
12.5/80 - 18	IM-04	TT	11×18 (9×18)	12 - 18 HS 12.5 - 18	308	965	444	2 840



	Ply rating PR	Service description LI/SS	Tire load capacity (kg) at speed (km/h)					Tire pressure (bar)
			10	20	30	40	50	
10 PR	131 A8	2 325	2 090	1 860	1 660	1 495	2.00	
		2 595	2 335	2 080	1 855	1 670	2.40	
		2 730	2 455	2 185	1 950	1 755	2.60	
14 PR	137 A8	2 830	2 545	2 260	2 020	1 820	2.80	
		2 970	2 670	2 375	2 120	1 910	3.10	
		3 050	2 745	2 440	2 180	1 960	3.30	
		3 135	2 820	2 510	2 240	2 015	3.50	
		3 220	2 900	2 575	2 300	2 070	3.70	
14 PR	144 A8	2 605	2 345	2 085	1 860	1 675	2.00	
		2 980	2 685	2 385	2 130	1 915	2.50	
		3 305	2 975	2 645	2 360	2 125	3.00	
		3 625	3 265	2 900	2 590	2 330	3.50	
		3 920	3 530	3 135	2 800	2 520	4.00	
18 PR	157 A8	5 110	4 600	4 090	3 650	3 285	4.75	
		5 320	4 790	4 255	3 800	3 420	5.00	
		5 545	4 990	4 435	3 960	3 565	5.25	
		5 775	5 195	4 620	4 125	3 715	5.50	
14 PR	149 A8	3 330	3 000	2 665	2 380	2 140	2.00	
		3 815	3 435	3 050	2 725	2 455	2.50	
		4 200	3 780	3 360	3 000	2 700	3.00	
		4 550	4 095	3 640	3 250	2 925	3.50	
18 PR	155 A8	4 985	4 485	3 985	3 560	3 200	4.00	
		5 425	4 880	4 340	3 875	3 490	4.40	
14 PR	145 A8	2 715	2 445	2 175	1 940	1 745	2.25	
		2 885	2 595	2 305	2 060	1 855	2.50	
		3 305	2 975	2 645	2 360	2 125	3.00	
		3 565	3 205	2 850	2 545	2 290	3.50	
		3 870	3 485	3 095	2 765	2 490	4.00	
		4 060	3 655	3 250	2 900	2 610	4.25	
16 PR	147 A8	4 145	3 730	3 315	2 960	2 665	4.50	
		4 305	3 875	3 445	3 075	2 770	5.00	
14 PR	145 A8	2 715	2 445	2 175	1 940	1 745	2.25	
		2 885	2 595	2 305	2 060	1 855	2.50	
		3 305	2 975	2 645	2 360	2 125	3.00	
		3 565	3 205	2 850	2 545	2 290	3.50	
		3 870	3 485	3 095	2 765	2 490	4.00	
		4 060	3 655	3 250	2 900	2 610	4.25	
16 PR	147 A8	4 145	3 730	3 315	2 960	2 665	4.50	
		4 305	3 875	3 445	3 075	2 770	5.00	

IM series

Technical data and load capacities

Tire size	Tread pattern	Type	Rim (permitted)	Tube	Section width (mm)	Overall diameter (mm)	Loaded static radius (mm)	Rolling circumference (mm)
13.0/65 - 18	IM-04	TT/TL	11 × 18	13.0/65 - 18	336	890	412	2 615
360/95 - 18 (13.00 - 18)	IM-02	TT	9A × 18	12.00 - 18	370	1 128	514	3 315
14.5/80 - 18	IM-03	TT	13 × 18	14.5/80 - 18	372	1 045	475	3 075
500/60 - 22.5	IM-09	TL	16.00 × 22.5	–	503	1 172	511	3 446
550/60 - 22.5	IM-09	TL	16.00 × 22.5	–	537	1 232	534	3 622

⁰¹ Reinforced version for TL type also available (REINFORCED)

For Non-standard version, please contact a producer.

These tires are for normal agricultural use and not for continuous highway service.

TL = Tubeless

TT = Tube Type



	Ply rating PR	Service description LI/SS	Tire load capacity (kg) at speed (km/h)					Tire pressure (bar)
			10	20	30	40	50	
16 PR⁽³⁾	143 A8	2 270	2 040	1 815	1 620	1 460	2.00	
		2 575	2 320	2 060	1 840	1 655	2.50	
		2 885	2 595	2 305	2 060	1 855	3.00	
		3 220	2 900	2 575	2 300	2 070	3.50	
		3 400	3 060	2 720	2 430	2 185	4.00	
		3 605	3 245	2 885	2 575	2 320	4.50	
		3 815	3 435	3 050	2 725	2 455	5.00	
12 PR	150 A8	3 555	3 200	2 845	2 540	2 285	2.50	
		4 200	3 780	3 360	3 000	2 700	3.00	
		4 690	4 220	3 750	3 350	3 015	3.50	
12 PR	155 A8	2 850	2 565	2 280	2 035	1 830	1.50	
		3 310	2 980	2 650	2 365	2 130	2.00	
		3 765	3 390	3 015	2 690	2 420	2.50	
		4 215	3 795	3 370	3 010	2 710	3.00	
		4 660	4 195	3 730	3 330	2 995	3.50	
		5 125	4 610	4 100	3 660	3 295	4.00	
		5 425	4 885	4 340	3 875	3 490	4.25	
16 PR	159 A8	3 955	3 560	3 165	2 825	2 545	1.50	
		4 390	3 950	3 510	3 135	2 820	1.80	
		4 825	4 340	3 860	3 445	3 100	2.10	
		5 250	4 725	4 200	3 750	3 375	2.40	
		5 690	5 120	4 555	4 065	3 660	2.70	
		6 125	5 515	4 900	4 375	3 940	3.00	
16 PR	163 A8	4 780	4 305	3 825	3 415	3 075	1.50	
		5 125	4 610	4 100	3 660	3 295	1.70	
		5 455	4 910	4 360	3 895	3 505	1.90	
		5 775	5 200	4 620	4 125	3 715	2.10	
		6 235	5 615	4 990	4 455	4 010	2.40	
		6 530	5 880	5 225	4 665	4 200	2.60	
		6 825	6 145	5 460	4 875	4 390	2.80	



TR-01

Tread pattern with excellent traction, suitable for all self-propelled machines, agricultural loaders, small dump trucks and telescopic loaders.



TR-03

Universal traction pattern for different agricultural applications.



TR-04

All-round tread pattern with great traction for a wide range of agricultural uses.



TR-05

Time proven pattern for agricultural application with very good traction.



TR-06

Low-profile traction pattern for use in meadowlands, suitable for drive wheels.



TR-07

Low-profile tread pattern with great traction, recommended for meadowland use.



TR-08

Flotation pattern with reduced soil compaction due to low inflation pressure. Great traction, breaking performance and lateral stability.



TR-10

Tread pattern suitable above all for bigger skid-steer loaders or self-propelled plat-forms. Recommended also for front wheels of back-hoe loaders.

TR series – Implement diagonal

Traction tires for wide agricultural application



TR-11

Tread pattern with robust lugs, ensuring very good traction. Suitable for loaders and side dumpers.



TR-12

Pattern with excellent traction, developed for powered wheels of agricultural and industrial machinery. Applicable for trailed wheels as well.

Tire size	TR-01	TR-03	TR-04	TR-05	TR-06	TR-07	TR-08	TR-10	TR-11	TR-12
31x15.50-15					•	•				
10.0/75-15.3		•	•							
11.5/80-15.3		•								
400/60-15.5							•			
15.0/55-17	•									
480/45-17	•									
14-17.5								•		
12.0/75-18		•							•	
14.5/80-18				•						
400/70-20	•									
500/45-20										•
500/60-22.5							•			•
550/60-22.5							•			•
600/40-22.5										•
600/50-22.5							•			

TR series

Technical data and load capacities

Tire size	Tread pattern	Type	Rim (permitted)	Tube	Section width (mm)	Overall diameter (mm)	Loaded static radius (mm)	Rolling circumference (mm)
31×15.50-15 (400/50-15)	TR-06	TL	13LB×15	–	370	760	350	2 235
31×15.50-15 (400/50-15)	TR-07	TL	13LB×15	–	370	760	350	2 235
10.0/75-15.3	TR-03	TL	9.00×15.3	10-15 HS 10/75-15	264	780	360	2 295
10.0/75-15.3	TR-03	TL	9.00×15.3	10-15 HS 10/75-15	264	780	360	2 295
10.0/75-15.3	TR-04	TL	9.00×15.3	10-15 HS 10/75-15	264	780	360	2 295
11.5/80-15.3	TR-03	TL	9.00×15.3	11.5/80-15	290	867	395	2 550
11.5/80-15.3	TR-03	TL	9.00×15.3	11.5/80-15	290	867	395	2 550
400/60-15.5	TR-08	TL	13.00×15.5	–	390	865	385	2 546
400/60-15.5	TR-08	TL	13.00×15.5	–	390	865	385	2 546



	Ply rating PR	Service description L/SS	Tire load capacity (kg) – free rolling / drive wheel – at speed (km/h)					Tire pressure (bar)
			10	20	30	40	50	
8 PR	121/109 A8	1 045 / 730	940 / 655	835 / 580	745 / 520	670 / 470	1.00	
		1 295 / 910	1 165 / 820	1 035 / 730	925 / 650	835 / 585	1.50	
		1 555 / 1 090	1 400 / 985	1 245 / 875	1 110 / 780	1 000 / 700	2.00	
		1 805 / 1 265	1 625 / 1 140	1 445 / 1 015	1 290 / 905	1 160 / 815	2.50	
		2 030 / 1 440	1 825 / 1 300	1 625 / 1 155	1 450 / 1 030	1 305 / 925	3.00	
8 PR	121/109 A8	1 045 / 730	940 / 655	835 / 580	745 / 520	670 / 470	1.00	
		1 295 / 910	1 165 / 820	1 035 / 730	925 / 650	835 / 585	1.50	
		1 555 / 1 090	1 400 / 985	1 245 / 875	1 110 / 780	1 000 / 700	2.00	
		1 805 / 1 265	1 625 / 1 140	1 445 / 1 015	1 290 / 905	1 160 / 815	2.50	
		2 030 / 1 440	1 825 / 1 300	1 625 / 1 155	1 450 / 1 030	1 305 / 925	3.00	
10 PR	122/111 A8	1 665 / 1 210	1 500 / 1 090	1 335 / 970	1 190 / 865	1 070 / 780	2.50	
		1 755 / 1 275	1 580 / 1 145	1 405 / 1 020	1 255 / 910	1 130 / 820	2.75	
		1 850 / 1 330	1 665 / 1 195	1 480 / 1 065	1 320 / 950	1 190 / 855	3.00	
		1 910 / 1 380	1 720 / 1 240	1 530 / 1 105	1 365 / 985	1 230 / 885	3.25	
		1 975 / 1 430	1 775 / 1 285	1 580 / 1 140	1 410 / 1 020	1 270 / 920	3.50	
2 100 / 1 525	1 890 / 1 375	1 680 / 1 220	1 500 / 1 090	1 350 / 980	4.00			
14 PR	130/118 A8	2 170 / 1 570	1 955 / 1 410	1 735 / 1 255	1 550 / 1 120	1 395 / 1 010	4.25	
		2 240 / 1 610	2 015 / 1 450	1 790 / 1 290	1 600 / 1 150	1 440 / 1 035	4.50	
		2 310 / 1 650	2 080 / 1 485	1 850 / 1 320	1 650 / 1 180	1 485 / 1 060	4.75	
		2 430 / 1 715	2 185 / 1 545	1 945 / 1 370	1 735 / 1 225	1 560 / 1 105	5.00	
		2 550 / 1 780	2 295 / 1 600	2 040 / 1 420	1 820 / 1 270	1 640 / 1 145	5.25	
2 660 / 1 850	2 395 / 1 665	2 130 / 1 480	1 900 / 1 320	1 710 / 1 190	5.50			
10 PR	122/111 A8	1 665 / 1 210	1 500 / 1 090	1 335 / 970	1 190 / 865	1 070 / 780	2.50	
		1 755 / 1 275	1 580 / 1 145	1 405 / 1 020	1 255 / 910	1 130 / 820	2.75	
		1 850 / 1 330	1 665 / 1 195	1 480 / 1 065	1 320 / 950	1 190 / 855	3.00	
		1 910 / 1 380	1 720 / 1 240	1 530 / 1 105	1 365 / 985	1 230 / 885	3.25	
		1 975 / 1 430	1 775 / 1 285	1 580 / 1 140	1 410 / 1 020	1 270 / 920	3.50	
2 100 / 1 525	1 890 / 1 375	1 680 / 1 220	1 500 / 1 090	1 350 / 980	4.00			
10 PR	130/119 A8	1 820 / 1 510	1 640 / 1 360	1 455 / 1 210	1 300 / 1 080	1 170 / 970	2.25	
		2 065 / 1 580	1 860 / 1 425	1 650 / 1 265	1 475 / 1 130	1 330 / 1 015	2.50	
		2 430 / 1 735	2 185 / 1 560	1 945 / 1 390	1 735 / 1 240	1 560 / 1 115	3.00	
		2 660 / 1 905	2 395 / 1 715	2 130 / 1 525	1 900 / 1 360	1 710 / 1 225	3.50	
		2 970 / 2 170	2 670 / 1 955	2 375 / 1 735	2 120 / 1 550	1 910 / 1 395	4.00	
3 260 / 2 310	2 935 / 2 080	2 610 / 1 850	2 330 / 1 650	2 095 / 1 485	4.50			
3 400 / 2 380	3 060 / 2 140	2 720 / 1 905	2 430 / 1 700	2 185 / 1 530	4.75			
14 PR	140/127 A8	2 015 / 1 420	1 815 / 1 280	1 615 / 1 135	1 440 / 1 015	1 295 / 915	1.25	
		2 185 / 1 525	1 965 / 1 375	1 745 / 1 220	1 560 / 1 090	1 405 / 980	1.50	
		2 520 / 1 750	2 270 / 1 575	2 015 / 1 400	1 800 / 1 250	1 620 / 1 125	2.00	
		2 800 / 1 975	2 520 / 1 775	2 240 / 1 580	2 000 / 1 410	1 800 / 1 270	2.50	
		3 150 / 2 205	2 835 / 1 985	2 520 / 1 765	2 250 / 1 575	2 025 / 1 420	3.00	
3 500 / 2 450	3 150 / 2 205	2 800 / 1 960	2 500 / 1 750	2 250 / 1 575	3.50			
⁽¹⁾	145/132 A8	4 060 / 2 800	3 650 / 2 520	3 250 / 2 240	2 900 / 2 000	2 610 / 1 800	3.60	

¹ Reinforced version (REINFORCED)

TR series

Technical data and load capacities

Tire size	Tread pattern	Type	Rim (permitted)	Tube	Section width (mm)	Overall diameter (mm)	Loaded static radius (mm)	Rolling circumference (mm)
400/60 - 15.5	TR-08	TL	13.00×15.5	–	390	865	385	2 546
15.0/55 - 17	TR-01	TL	13.00×17 (13×17)	–	391	872	410	2 565
15.0/55 - 17	TR-01	TL	13.00×17 (13×17)	–	391	872	410	2 565
15.0/55 - 17	TR-01	TL	13.00×17	–	391	872	410	2 565
480/45 - 17 IMP	TR-01	TL	15.00×17 (16.00×17)	–	479	864	410	2 576
14 - 17.5	TR-10	TL	10.50×17.5	–	355	910	430	2 858
12.0/75 - 18	TR-03	TL	W9×18 (9.11×18)	12.0 - 18	299	937	447	2 755
12.0/75 - 18	TR-11	TL	W9×18 (9.11×18)	12.0 - 18	299	937	447	2 755
14.5/80 - 18	TR-05	TT	13×18	14.5/80 - 18	372	1 045	475	3 075
500/45 - 20	TR-12	TL	16.00×20 DC	–	490	980	445	2 910



	Ply rating PR	Service description LI/SS	Tire load capacity (kg) – free rolling / drive wheel – at speed (km/h)					Tire pressure (bar)
			10	20	30	40	50	
		152/140 A8	4410 / 3135 4690 / 3305 4970 / 3500	3970 / 2820 4220 / 2975 4475 / 3150	3530 / 2510 3750 / 2645 3975 / 2800	3150 / 2240 3350 / 2360 3550 / 2500	2835 / 2015 3015 / 2125 3195 / 2250	4.00 5.00 6.00
	10 PR	131/119 A8	2 325 / 1 615 2 465 / 1 710 2 595 / 1 815 2 730 / 1 905	2 090 / 1 455 2 220 / 1 535 2 335 / 1 630 2 455 / 1 715	1 860 / 1 295 1 970 / 1 365 2 080 / 1 450 2 185 / 1 525	1 660 / 1 155 1 760 / 1 220 1 855 / 1 295 1 950 / 1 360	1 495 / 1 040 1 585 / 1 100 1 670 / 1 165 1 755 / 1 225	2.00 2.20 2.40 2.60
	12 PR	134/122 A8	2 830 / 1 990 2 970 / 2 100	2 545 / 1 790 2 670 / 1 890	2 260 / 1 590 2 375 / 1 680	2 020 / 1 420 2 120 / 1 500	1 820 / 1 280 1 910 / 1 350	2.80 3.10
	14 PR	137/125A8	3 050 / 2 135 3 135 / 2 200 3 220 / 2 310	2 745 / 1 920 2 820 / 1 980 2 900 / 2 080	2 440 / 1 710 2 510 / 1 760 2 575 / 1 850	2 180 / 1 525 2 240 / 1 570 2 300 / 1 650	1 960 / 1 370 2 015 / 1 415 2 070 / 1 485	3.30 3.50 3.70
		146/134 A8	1 638 / 1 158 2 100 / 1 484 2 604 / 1 840 2 982 / 2 107 3 444 / 2 434 3 906 / 2 760 4 200 / 2 968	1 474 / 1 042 1 890 / 1 336 2 344 / 1 656 2 684 / 1 897 3 100 / 2 190 3 515 / 2 484 3 780 / 2 671	1 310 / 926 1 680 / 1 187 2 083 / 1 472 2 386 / 1 686 2 755 / 1 947 3 125 / 2 208 3 360 / 2 374	1 170 / 827 1 500 / 1 060 1 860 / 1 314 2 130 / 1 505 2 460 / 1 738 2 790 / 1 972 3 000 / 2 120	1 053 / 744 1 350 / 954 1 674 / 1 183 1 917 / 1 355 2 214 / 1 565 2 511 / 1 774 2 700 / 1 908	0.80 1.20 1.60 2.00 2.40 2.80 3.20
	14 PR	150/139 B	3 890 / 2 760 4 060 / 2 890 4 240 / 3 030 4 410 / 3 165 4 640 / 3 345 4 930 / 3 565 5 210 / 3 780	3 505 / 2 480 3 655 / 2 600 3 820 / 2 730 3 970 / 2 850 4 175 / 3 010 4 435 / 3 205 4 685 / 3 400	3 115 / 2 205 3 250 / 2 315 3 395 / 2 425 3 530 / 2 530 3 715 / 2 675 3 940 / 2 850 4 166 / 3 025	2 780 / 1 970 2 900 / 2 065 3 030 / 2 165 3 150 / 2 260 3 315 / 2 390 3 520 / 2 545 3 720 / 2 700	2 500 / 1 775 2 610 / 1 860 2 725 / 1 950 2 835 / 2 035 2 985 / 2 150 3 170 / 2 290 3 350 / 2 430	3.20 3.50 3.80 4.10 4.50 5.00 5.50
	12 PR	139/126 A8	3 150 / 2 225 3 400 / 2 380	2 835 / 2 005 3 060 / 2 140	2 520 / 1 780 2 720 / 1 905	2 250 / 1 590 2 430 / 1 700	2 025 / 1 430 2 185 / 1 530	3.50 4.00
	12 PR	135/123 A8	2 490 / 1 800 2 610 / 1 870 2 835 / 2 025 3 050 / 2 170	2 245 / 1 620 2 350 / 1 680 2 550 / 1 820 2 745 / 1 955	1 995 / 1 440 2 090 / 1 500 2 270 / 1 620 2 440 / 1 735	1 780 / 1 285 1 865 / 1 335 2 025 / 1 445 2 180 / 1 550	1 600 / 1 155 1 680 / 1 200 1 825 / 1 300 1 960 / 1 395	2.75 3.00 3.50 4.00
	12 PR	155/143 A8	3 765 / 2 660 4 445 / 3 155 4 895 / 3 485 5 425 / 3 815	3 390 / 2 395 4 000 / 2 840 4 405 / 3 135 4 885 / 3 435	3 015 / 2 130 3 555 / 2 525 3 915 / 2 790 4 340 / 3 050	2 690 / 1 900 3 175 / 2 255 3 495 / 2 490 3 875 / 2 725	2 420 / 1 710 2 860 / 2 030 3 145 / 2 240 3 490 / 2 455	2.50 3.25 3.75 4.25
		162/150 A8	5 775 / 4 060 6 125 / 4 305 6 650 / 4 690	5 200 / 3 655 5 510 / 3 875 5 985 / 4 220	4 620 / 3 250 4 900 / 3 445 5 320 / 3 750	4 125 / 2 900 4 375 / 3 075 4 750 / 3 350	3 710 / 2 610 3 940 / 2 770 4 275 / 3 015	4.00 5.00 6.00

TR series

Technical data and load capacities

Tire size	Tread pattern	Type	Rim (permitted)	Tube	Section width (mm)	Overall diameter (mm)	Loaded static radius (mm)	Rolling circumference (mm)
500/60 - 22.5	TR-08	TL	16.00×22.5	–	503	1 192	519	3 504
500/60 - 22.5	TR-12	TL	16.00×22.5 DC	–	503	1 192	519	3 504
500/60 - 22.5	TR-12	TL	16.00×22.5	–	503	1 192	519	3 504
550/60 - 22.5	TR-08	TL	16.00×22.5	–	537	1 254	542	3 687
550/60 - 22.5	TR-08	TL	16.00×22.5	–	537	1 254	542	3 687
600/40 - 22.5	TR-12	TL	20.00TH2×22.5 (20.00DC)	–	600	1 050	473	3 146
600/40 - 22.5	TR-12	TL	20.00TH2×22.5 (20.00DC)	–	600	1 050	473	3 146
600/50 - 22.5	TR-08	TL	20.00×22.5	–	595	1 140	510	3 380
600/50 - 22.5	TR-08 HD	TL	20.00×22.5	–	611	1 172	510	3 440

For Non-standard version, please contact a producer.

These tires are for normal agricultural use and not for continuous highway service.

TL = Tubeless

TT = Tube Type

TR-08



TR-12



	Ply rating PR	Service description LI/SS	Tire load capacity (kg) – free rolling / drive wheel – at speed (km/h)					Tire pressure (bar)	
			10	20	30	40	50		
16 PR	159/147 A8	3 955 / 2 700	3 560 / 2 430	3 165 / 2 160	2 825 / 1 930	2 545 / 1 735	1.50		
		4 390 / 3 050	3 950 / 2 745	3 510 / 2 440	3 135 / 2 180	2 820 / 1 960	1.80		
		4 825 / 3 390	4 340 / 3 050	3 860 / 2 710	3 445 / 2 420	3 100 / 2 180	2.10		
		5 250 / 3 710	4 725 / 3 340	4 200 / 2 970	3 750 / 2 650	3 375 / 2 385	2.40		
		5 690 / 4 010	5 120 / 3 610	4 555 / 3 210	4 065 / 2 865	3 660 / 2 580	2.70		
		6 125 / 4 305	5 515 / 3 875	4 900 / 3 445	4 375 / 3 075	3 940 / 2 770	3.00		
165/153 A8		6125 / 4305	5510 / 3875	4900 / 3445	4375 / 3075	3940 / 2770	2.80		
		6650 / 4690	5985 / 4220	5320 / 3750	4750 / 3350	4275 / 3015	3.20		
		7210 / 4970	6490 / 4475	5780 / 3975	5150 / 3550	4635 / 3195	3.60		
170/158 A8		7 840 / 5 600	7 055 / 5 040	6 270 / 4 480	5 600 / 4 000	5 040 / 3 600	4.00		
		8 400 / 5 950	7 560 / 5 355	6 720 / 4 760	6 000 / 4 250	5 400 / 3 825	4.50		
16 PR	167/155 A8	3 205 / 2 279	2 884 / 2 051	2 564 / 1 823	2 289 / 1 628	2 060 / 1 465	0.80		
		4 120 / 2 930	3 708 / 2 637	3 296 / 2 344	2 943 / 2 093	2 649 / 1 883	1.20		
		5 036 / 3 581	4 532 / 3 222	4 029 / 2 864	3 597 / 2 558	3 237 / 2 302	1.60		
		5 799 / 4 123	5 219 / 3 711	4 639 / 3 298	4 142 / 2 945	3 728 / 2 651	2.00		
		6 714 / 4 774	6 043 / 4 297	5 372 / 3 819	4 796 / 3 410	4 316 / 3 069	2.40		
		7 630 / 5 425	6 867 / 4 883	6 104 / 4 340	5 450 / 3 875	4 905 / 3 488	2.80		
171/159 A8		7 060 / 4 940	6 495 / 4 540	5 930 / 4 150	5 650 / 3 950	4 800 / 3 360	3.00		
		7 360 / 5 220	6 775 / 4 800	6 185 / 4 385	5 890 / 4 175	5 005 / 3 550	3.20		
		7 700 / 5 470	7 070 / 5 030	6 500 / 4 640	6 150 / 4 375	5 225 / 3 720	3.40		
161/149 A8		2 520 / 1 750	2 270 / 1 575	2 015 / 1 400	1 800 / 1 250	1 620 / 1 125	0.80		
		3 220 / 2 310	2 900 / 2 080	2 575 / 1 850	2 300 / 1 650	2 070 / 1 485	1.20		
		3 920 / 2 800	3 530 / 2 520	3 135 / 2 240	2 800 / 2 000	2 520 / 1 800	1.60		
		4 550 / 3 220	4 095 / 2 900	3 640 / 2 575	3 250 / 2 300	2 925 / 2 070	2.00		
		5 250 / 3 710	4 725 / 3 340	4 200 / 2 970	3 750 / 2 650	3 375 / 2 385	2.40		
		5 950 / 4 200	5 355 / 3 780	4 760 / 3 360	4 250 / 3 000	3 825 / 2 700	2.80		
6 475 / 4 550	5 830 / 4 095	5 180 / 3 640	4 625 / 3 250	4 160 / 2 925	3.20				
172/160 A8		7 000 / 4 970	6 300 / 4 475	5 600 / 3 975	5 000 / 3 550	4 500 / 3 195	3.60		
		7 840 / 5 600	7 055 / 5 040	6 270 / 4 480	5 600 / 4 000	5 040 / 3 600	4.00		
		8 120 / 5 775	7 310 / 5 200	6 495 / 4 620	5 800 / 4 125	5 220 / 3 710	5.00		
		8 820 / 6 300	7 940 / 5 670	7 055 / 5 040	6 300 / 4 500	5 670 / 4 050	6.00		
16 PR	165/153 A8	4 440 / 3 025	3 995 / 2 720	3 550 / 2 420	3 170 / 2 160	2 855 / 1 945	1.10		
		4 830 / 3 305	4 345 / 2 975	3 865 / 2 645	3 450 / 2 360	3 105 / 2 125	1.30		
		5 395 / 3 690	4 855 / 3 320	4 320 / 2 950	3 855 / 2 635	3 470 / 2 370	1.60		
		5 760 / 3 940	5 185 / 3 545	4 610 / 3 155	4 115 / 2 815	3 705 / 2 535	1.80		
		6 125 / 4 200	5 515 / 3 780	4 900 / 3 360	4 375 / 3 000	3 940 / 2 700	2.00		
		6 670 / 4 650	6 005 / 4 185	5 335 / 3 720	4 765 / 3 320	4 290 / 2 990	2.30		
		7 210 / 5 110	6 490 / 4 600	5 770 / 4 090	5 150 / 3 650	4 635 / 3 285	2.60		
		168/156 A8		7 840 / 5 600	7 055 / 5 040	6 270 / 4 480	5 600 / 4 000	5 040 / 3 600	3.20



TS-02

Universal traction pattern for a wide range of gardening applications.



TS-04

All-round tread pattern with excellent traction.



TS-05

Pattern with very good traction and handling. Also suitable for light industrial use.



TS-06

Improved tread pattern with great traction.



TS-07

Pattern specially developed for seed drill machines for soil compaction. Applicable for drive wheels as well.



TD-10

Lugged tread pattern for powered axle.



TD-13

A classic tread pattern design, well-tested and proven.



B 12

Universal traction pattern for a wide range of gardening applications.

Tractor small tires

For all kinds of gardening equipment



B 16

Tread pattern with deep and robust lugs for greater traction.



B 17

Lugged tread pattern with excellent traction.



B 18

Universal tread pattern with great traction.



B 64

Universal traction pattern for a wide range of gardening applications.

Tractor small tires

Technical data and load capacities

Tire size	Tread pattern	Type	Rim (permitted)	Tube	Section width (mm)	Overall diameter (mm)	Loaded static radius (mm)	Rolling circumference (mm)
3.50-6	B 16	TT	2.50×6	4.00-6	96	343	157	1 026
13×5.00-6	B 12	TT/TL	3.50×6	4.00-6	120	328	151	981
3.50-8	B 16	TT	2.50×8	3.50/4.00-8	96	395	183	1 181
4.00-8	B 12	TT	3.00×8	3.50/4.00-8	105	425	196	1 271
4.00-8	B 12	TT	3.00×8	3.50/4.00-8	105	425	196	1 271
16×6.50-8	B 64	TL	5.375×8	16×6.50/7.50-8	165	408	189	1 220
16×6.50-8	B 64	TL	5.375×8	16×6.50/7.50-8	165	408	189	1 220
4.00-10	B 12	TT	3.00×10	4.00-10	109	470	219	1 405
4.00-10	B 12	TT	3.00×10	4.00-10	109	470	219	1 405
5.00-10	B 16	TT	3.00×10	5.00-10	132	520	240	1 555
5.0-10	B 17	TT	3.50×10	5.00-10	135	515	238	1 540
5.0-10	B 17	TT	3.50×10	5.00-10	135	515	238	1 540
4.00-12	B 12	TT	3.00×12	4.00-12	109	530	248	1 585
5.00-12	TS-02	TT	4.00E×12 (3.00D×12)	5.00-12	145	580	260	1 705
5.00-12	TS-02	TT	4.00E×12 (3.00D×12)	5.00-12	145	580	260	1 705
5.00-12	B 12	TT	4.00×12	5.00-12	145	575	267	1 719
5.00-12	B 12	TT	4.00×12	5.00-12	145	575	267	1 719
6.5/90-12 (170/90-12)	TS-06	TT	5J×12 (5JA×12)	6.5/80-12	165	615	278	1 810
6.5/80-12	B 18	TT	5.00×12	5.00-12	165	600	278	1 794



	Ply rating PR	Service description LI/SS	Tire load capacity (kg) – free rolling / drive wheel – at speed (km/h)					Tire pressure (bar)
			10	20	25	30	40	
	4 PR	33 A6	- / 148	- / 131	- / 123	- / 115		3.00
	4 PR	49 A6	- / 239	- / 211	- / 198	- / 185		2.25
	4 PR	35 A6	- / 156	- / 138	- / 129	- / 121		3.00
	2 PR	31 A6	- / 141	- / 124	- / 117	- / 109		1.50
	4 PR	44 A6	- / 206	- / 182	- / 171	- / 160		2.75
	4 PR	52 A6	- / 258	- / 228	- / 214	- / 200		1.90
	8 PR	69 A6	- / 419	- / 371	- / 348	- / 325		4.25
	2 PR	37 A6	- / 165	- / 146	- / 137	- / 128		1.50
	4 PR	49 A6	- / 239	- / 211	- / 198	- / 185		2.75
	4 PR	59 A6	- / 313	- / 277	- / 260	- / 243		2.25
	2 PR	48 A6	- / 232	- / 205	- / 193	- / 180		1.25
	4 PR	61 A6	- / 332	- / 293	- / 275	- / 257		2.25
	4 PR	54 A6	- / 273	- / 242	- / 227	- / 212		2.75
	2 PR	61/48 A6	290 / 200 330 / 230	255 / 180 295 / 205	240 / 165 275 / 195	225 / 155 257 / 180	205 / 140 230 / 165	1.00 1.25
	6 PR	78/66 A6	370 / 260	325 / 230	305 / 215	285 / 200	255 / 180	1.50
			405 / 295	360 / 260	335 / 245	315 / 225	285 / 205	1.75
			445 / 320	395 / 280	370 / 260	345 / 245	310 / 225	2.00
			485 / 340	430 / 300	400 / 285	375 / 265	340 / 240	2.25
			495 / 350	440 / 310	410 / 290	385 / 270	345 / 245	2.50
			520 / 370	460 / 325	435 / 305	405 / 285	365 / 260	3.00
			550 / 390	485 / 345	455 / 325	425 / 300	385 / 270	3.50
	2 PR	48 A6	- / 232	- / 205	- / 193	- / 180		1.25
	4 PR	62 A6	- / 342	- / 302	- / 284	- / 265		2.25
	6 PR	89/76 A8	365 / 265	330 / 235	310 / 225	290 / 210	260 / 188	0.80
			400 / 285	360 / 255	340 / 240	315 / 225	285 / 202	1.00
			430 / 305	385 / 275	365 / 260	345 / 245	307 / 218	1.20
			475 / 345	430 / 310	405 / 290	375 / 275	340 / 245	1.50
			555 / 405	500 / 365	470 / 345	440 / 325	395 / 288	2.00
			610 / 440	550 / 395	520 / 375	500 / 355	437 / 315	2.40
			695 / 475	625 / 425	590 / 400	550 / 380	495 / 338	2.75
			730 / 505	655 / 455	620 / 430	580 / 405	520 / 362	3.00
			810 / 560	730 / 505	690 / 475	650 / 450	580 / 400	3.50
			4 PR	72 A6	- / 458	- / 405	- / 380	- / 355

Tractor small tires

Technical data and load capacities

Tire size	Tread pattern	Type	Rim (permitted)	Tube	Section width (mm)	Overall diameter (mm)	Loaded static radius (mm)	Rolling circumference (mm)	
11.0/65-12	TD-10	TT	9.00×12 (7.00×12)	–	281 261	692	310	2 125	
6.5/75-14	TS-02	TT	5J×14	155/165-14	150	610	283	1 830	
5.00-15	TS-06	TT	3.00D×15 (4J×15)	5.00-15	129	661	307	1 985	
6.5/90-15 (170/90-15)	TS-06	TT	5J×15 (41/2K×15)	6.5/80-15	163	695	318	2 040	
6.5/90-15 (170/90-15)	TS-06	TT	5J×15 (41/2K×15)	6.5/80-15	163	695	318	2 040	
690×180-15	TS-07	TT	5J×15		176	690	309	2 056	
10.0/75-15.3	TS-05	TL	9.00×15.3	10-15 HS 10/75-15	264	780	360	2 295	
11.5/80-15.3	TS-05	TL	9.00×15.3	11.5/80-15	290	867	410	2 550	
11.5/80-15.3	TS-05	TL	9.00×15.3	11.5/80-15	290	867	410	2 550	



	Ply rating PR	Service description LI/SS	Tire load capacity (kg) – free rolling / drive wheel – at speed (km/h)					Tire pressure (bar)
			10	20	25	30	40	
8 PR			- / 820	- / 725	- / 680	- / 635		1.00
			- / 1 160	- / 1 025	- / 965	- / 900		1.80
			- / 1 380	- / 1 220	- / 1 145	- / 1 070		2.50
			- / 1 445	- / 1 275	- / 1 200	- / 1 120		2.80
			- / 1 640	- / 1 450	- / 1 355	- / 1 270		3.40
4 PR	72/60 A6		335 / 235	295 / 215	280 / 195	260 / 185	235 / 170	1.00
			425 / 300	375 / 265	355 / 250	330 / 230	295 / 210	1.50
			460 / 325	405 / 285	380 / 270	355 / 250	320 / 225	1.70
6 PR	84/71 A8		396 / 270	357 / 243	337 / 230	315 / 218	283 / 193	1.25
			434 / 300	391 / 270	369 / 255	344 / 241	310 / 214	1.50
			507 / 357	456 / 321	431 / 303	402 / 288	362 / 255	2.00
			542 / 381	488 / 343	461 / 324	425 / 307	387 / 272	2.20
			578 / 405	520 / 364	491 / 344	456 / 325	413 / 289	2.50
			638 / 444	575 / 399	543 / 377	508 / 356	456 / 317	3.00
			700 / 483	630 / 435	595 / 411	560 / 387	500 / 345	3.50
6 PR	94/82 A8		435 / 310	390 / 280	370 / 265	345 / 250	310 / 222	0.80
			475 / 335	430 / 300	405 / 285	375 / 270	340 / 239	1.00
			495 / 350	445 / 315	420 / 300	400 / 280	355 / 250	1.20
			600 / 435	540 / 395	510 / 370	475 / 350	430 / 312	1.50
			650 / 475	585 / 425	555 / 400	515 / 380	465 / 338	1.80
			705 / 515	635 / 460	600 / 435	560 / 410	505 / 367	2.10
			740 / 540	670 / 485	630 / 460	600 / 430	530 / 385	2.40
			790 / 560	710 / 505	670 / 475	630 / 450	565 / 401	2.70
			840 / 595	755 / 535	715 / 505	670 / 475	600 / 425	3.00
			890 / 630	800 / 565	755 / 535	710 / 505	635 / 450	3.30
940 / 665	845 / 600	795 / 565	750 / 530	670 / 475	3.60			
8 PR	100/88 A8		1 010 / 710	910 / 640	860 / 600	810 / 565	720 / 505	4.00
			1 065 / 740	960 / 670	905 / 630	850 / 595	760 / 530	4.40
			1 120 / 785	1 010 / 705	950 / 670	895 / 630	800 / 560	4.80
4 PR	100/88 A8		1 030 / 720	925 / 650	875 / 615	825 / 575	735 / 515	2.00
			1 120 / 785	1 010 / 705	950 / 665	890 / 625	800 / 560	2.50
10 PR	122/111 A8		1 665 / 1 210	1 500 / 1 090	1 415 / 1 030	1 335 / 970	1 190 / 865	2.50
			1 850 / 1 330	1 665 / 1 195	1 570 / 1 130	1 480 / 1 065	1 320 / 950	3.00
			1 910 / 1 380	1 720 / 1 240	1 625 / 1 170	1 530 / 1 105	1 320 / 950	3.25
			1 975 / 1 430	1 775 / 1 285	1 680 / 1 215	1 580 / 1 140	1 410 / 1 020	3.50
			2 100 / 1 525	1 890 / 1 375	1 785 / 1 295	1 680 / 1 220	1 500 / 1 090	4.00
10 PR	130/119 A8		1 820 / 1 510	1 640 / 1 360	1 545 / 1 285	1 455 / 1 210	1 300 / 1 080	2.25
			2 065 / 1 580	1 860 / 1 425	1 755 / 1 345	1 650 / 1 265	1 475 / 1 130	2.50
			2 430 / 1 735	2 185 / 1 560	2 065 / 1 475	1 945 / 1 390	1 735 / 1 240	3.00
			2 660 / 1 905	2 395 / 1 715	2 260 / 1 620	2 130 / 1 525	1 900 / 1 360	3.50
14 PR	139/126 A8		2 970 / 2 170	2 670 / 1 955	2 525 / 1 845	2 375 / 1 735	2 120 / 1 550	4.00
			3 260 / 2 310	2 935 / 2 080	2 775 / 1 965	2 610 / 1 850	2 330 / 1 650	4.50
			3 400 / 2 380	3 060 / 2 140	2 890 / 2 035	2 720 / 1 905	2 430 / 1 700	4.75

Tractor small tires

Technical data and load capacities

Tire size	Tread pattern	Type	Rim (permitted)	Tube	Section width (mm)	Overall diameter (mm)	Loaded static radius (mm)	Rolling circumference (mm)
6.00-16	TS-04	TT	4.50E × 16 (4.00E × 16)	6.00-16	169	735	345	2 160
6.00-16	TS-04	TT	4.50E × 16 (4.00E × 16)	6.00-16	169	735	345	2 160
6.00-16	TD-13	TT	4.50E × 16 (4.00E × 16)	6.00-16	169	735	345	2 160
6.50-16	TD-10	TL	4.50E × 16 (4.00E) (5.00F)	—	179 174 184	773	360	2 280
7.50-16	TS-04	TL	5.50F × 16 (5.00F, 6.00F)	7.50-16	205	803	375	2 360
7.50-16	TS-04	TT/TL	5.50F × 16 (5.00F, 6.00F)	7.50-16	205	803	375	2 360
7.50-16	TD-13	TT	5.50F × 16 (5.00F, 6.00F)	7.50-16	205	803	375	2 360
7.50-20	TS-04	TT	5.50F × 20 (6.00F × 20)	7.50-20	205	904	420	2 660
7.50-20	TD-13	TT	5.50F × 20 (6.00F × 20)	7.50-20	205	904	420	2 660
8.3-20	TD-13	TT	W7 × 20 (W6 × 20)	8.3-20	211	895	416	2 640

For Non-standard version, please contact a producer.

¹⁾ Reinforced version also available (REINFORCED)

These tires are for normal agricultural use and not for continuous highway service.

TL = Tubeless

TT = Tube Type



	Ply rating PR	Service description LI/SS	Tire load capacity (kg) – free rolling / drive wheel – at speed (km/h)					Tire pressure (bar)
			10	20	25	30	40	
6 PR	91/79 A8	625 / 440	560 / 395	530 / 375	500 / 350	445 / 315	1.50	
		730 / 520	655 / 465	620 / 440	580 / 410	520 / 370	2.00	
		820 / 580	735 / 525	695 / 495	655 / 460	585 / 415	2.50	
		860 / 610	775 / 550	730 / 520	690 / 490	615 / 437	2.75	
8 PR	100/88 A8	930 / 650	840 / 585	790 / 555	745 / 515	665 / 465	3.00	
		1 030 / 720	925 / 650	875 / 615	825 / 570	735 / 515	3.50	
		1 120 / 785	1 010 / 705	950 / 665	895 / 615	800 / 560	4.00	
6 PR	79 A8	- / 450	- / 395	- / 375	- / 350	- / 315	1.50	
		- / 530	- / 465	- / 440	- / 410	- / 370	2.00	
		- / 595	- / 525	- / 495	- / 460	- / 410	2.50	
		- / 630	- / 550	- / 520	- / 490	- / 437	2.80	
8 PR	99A8	- / 660	- / 625	- / 585	- / 545	- / 510	1.60	
		- / 850	- / 800	- / 750	- / 700	- / 655	2.40	
		- / 1 010	- / 955	- / 890	- / 830	- / 775	3.20	
6 PR	100/88 A8	905 / 630	815 / 565	770 / 535	720 / 500	645 / 450	1.50	
		1 065 / 740	960 / 665	905 / 630	850 / 585	760 / 525	2.00	
		1 120 / 785	1 010 / 705	950 / 665	895 / 630	800 / 560	2.25	
8 PR ³⁾	108/95 A8	1 220 / 840	1 095 / 755	1 035 / 715	975 / 665	870 / 600	2.50	
		1 360 / 935	1 220 / 840	1 155 / 795	1 085 / 740	970 / 665	3.00	
		1 400 / 965	1 260 / 870	1 190 / 820	1 120 / 775	1 000 / 690	3.25	
6 PR	100/88 A8	905 / 630	815 / 565	770 / 535	720 / 500	645 / 450	1.50	
		1 065 / 740	960 / 665	905 / 630	850 / 585	760 / 525	2.00	
		1 120 / 785	1 010 / 705	950 / 665	895 / 630	800 / 560	2.25	
6 PR	103/91 A8	985 / 690	890 / 620	840 / 585	790 / 545	705 / 490	1.50	
		1 155 / 810	1 040 / 730	980 / 690	925 / 640	825 / 575	2.00	
		1 225 / 680	1 105 / 775	1 040 / 730	980 / 690	875 / 615	2.25	
6 PR	103/91 A8	985 / 690	890 / 620	840 / 585	790 / 545	705 / 490	1.50	
		1 155 / 810	1 040 / 730	980 / 690	925 / 640	825 / 575	2.00	
		1 225 / 680	1 105 / 775	1 040 / 730	980 / 690	875 / 615	2.25	
6 PR	104/92 A8	915 / 530	810 / 465	760 / 440	710 / 410	630 / 370	0.80	
		1 045 / 660	925 / 580	865 / 545	810 / 510	720 / 460	1.20	
		1 175 / 785	1 035 / 695	975 / 655	910 / 610	810 / 550	1.60	
		1 305 / 915	1 150 / 810	1 080 / 760	1 010 / 710	900 / 630	2.00	



TF-01

Multi-rib tread profile without any lateral tread elements and side lugs.



TF-02

Multi-rib tread pattern with short, strong shoulder lugs. Secure track holding and good climbing capabilities when steering out of the furrow.



TF-03

Multi-rib tread pattern with very strong shoulder lugs and lateral tread elements.



TF-04

Pattern with high stability in track due to deep relief of design.



IM-05

Special tread pattern developed for steering wheels of industrial tractors.

Tractor front tires with balanced properties

For perfect handling on and off the road

Tire size	TF-01	TF-02	TF-03	TF-04	IM-05
6.00-16			•		
6.50-16			•		
7.50-16	•	•	•		
9.00-16			•		
10.00-16			•		
11L-16					•
6.00-18			•	•	
6.50-20			•		
7.50-20	•		•		



Tractor front tires

Technical data and load capacities

Tire size	Tread pattern	Type	Rim (permitted)	Tube	Section width (mm)	Overall diameter (mm)	Loaded static radius (mm)	Rolling circumference (mm)
6.00-16	TF-03	TT	4.50E×16 (4.00E, 5K, 5.00F)	6.00-16	165	735	340	2 160
6.50-16	TF-03	TT	4.50E×16 (4.00E, 5K, 5.00F, 5.50F)	6.50-16	175	760	350	2 230
7.50-16	TF-01	TT	5.50F×16 (5.00F, 6.00F)	7.50-16	205	805	370	2 365
7.50-16	TF-02	TT	5.50F×16 (5.00F, 6.00F)	7.50-16	218	820	383	2 398
7.50-16	TF-03	TT	5.50F×16 (5.00F, 6.00F)	7.50-16	205	805	370	2 365
7.50-16	TF-03	TT	5.50F×16 (5.00F, 6.00F)	7.50-16	205	805	370	2 365
9.00-16	TF-03	TT	W8×16 (6.00F, W7, W8L)	9.00-16	234	855	395	2 514



Ply rating PR	Service description LI/SS	Tire load capacity (kg) at speed (km/h)				Tire pres- sure (bar)
		10 *	20	30	40	
6 PR	88 A6 (80 A8)	445	400	295	235	1.00
		535	480	355	285	1.50
		630	565	420	335	2.00
		720	650	480	385	2.50
		805	720	535	430	3.00
		840	755	560	450	3.30
8 PR	97 A6 (89 A8)	475	425	315	250	1.00
		580	520	385	310	1.50
		685	615	455	365	2.00
		790	710	525	420	2.50
		900	810	600	480	3.00
		925	830	615	485	3.20
		1 065	960	710	560	4.00
		1 095	985	730	580	4.20
6 PR	98 A6 (90 A8)	780	700	520	415	1.50
		925	830	615	490	2.00
		1 050	945	700	560	2.50
		1 125	1 015	750	600	2.80
8 PR	103 A6 (96 A8)	780	700	520	415	1.50
		925	830	615	490	2.00
		1 050	945	700	560	2.50
		1 125	1 015	750	600	2.80
		1 160	1 045	775	620	3.10
		1 210	1 090	805	645	3.30
		1 260	1 135	840	670	3.50
		1 315	1 180	875	710	3.70
6 PR	98 A6 (90 A8)	780	700	520	415	1.50
		925	830	615	490	2.00
		1 050	945	700	560	2.50
		1 125	1 015	750	600	2.80
8 PR	103 A6 (96 A8)	1 160	1 045	775	620	3.10
		1 210	1 090	805	645	3.30
		1 260	1 135	840	670	3.50
		1 315	1 180	875	710	3.70
8 PR	111 A6 (103 A8)	835	750	555	445	1.00
		1 035	930	690	550	1.50
		1 245	1 120	830	665	2.00
		1 350	1 215	900	730	2.30
		1 450	1 300	965	770	2.50
		1 510	1 355	1 005	805	2.70
		1 570	1 410	1 045	835	2.90
		1 635	1 470	1 090	875	3.10

Tractor front tires

Technical data and load capacities

Tire size	Tread pattern	Type	Rim (permitted)	Tube	Section width (mm)	Overall diameter (mm)	Loaded static radius (mm)	Rolling circumference (mm)
10.00-16	TF-03	TT	W8×16 (W8L×16)	9.00-16 10.00-16	274	895	411	2 630
11L-16	IM-05 (F 3)	TL	W8×16	—	285	825	372	2 365
6.00-18	TF-03	TT	4.50E×18 (4.00E, 5K, 5.00F)	6.00-18	160	790	365	2 323
6.00-18	TF-04	TT	4.50E×18 (4.00E, 5K, 5.00F)	6.00-18	160	790	365	2 323
6.50-20	TF-03	TT	5.00F×20 (4.00E, 5.50F)	6.50-20 7.00-20	175	865	408	2 543
7.50-20	TF-01	TT	5.50F×20 (5.00F, 6.00F)	7.50-20	205	915	420	2 690
7.50-20	TF-03	TT	5.50F×20 (5.00F, 6.00F)	7.50-20	205	915	420	2 690

* Basic Inflation Pressure must be increased about 25%.

For Non-standard version, please contact a producer.

These tires are for normal agricultural use and not for continuous highway service.

TL = Tubeless

TT = Tube Type



Ply rating PR	Service description LI/SS	Tire load capacity (kg) at speed (km/h)				Tire pres- sure (bar)
		10 *	20	30	40	
8 PR	118 A6 (114 A8)	1 075	895	715	645	1.00
		1 335	1 110	890	800	1.50
		1 585	1 320	1 055	950	2.00
		1 835	1 530	1 220	1 100	2.50
		1 970	1 640	1 320	1 180	2.80
10 PR	119 A6 (115 A8)	1 150	1 035	920	820	2.00
		1 365	1 230	1 090	975	2.50
		1 520	1 365	1 215	1 085	3.00
		1 660	1 495	1 325	1 185	3.50
		1 700	1 530	1 360	1 215	3.75
6 PR	96 A6 (88 A8)	705	635	470	375	2.00
		855	770	570	455	2.50
		1 005	905	670	535	3.00
		1 065	960	710	560	3.20
6 PR	96 A6 (88 A8)	705	635	470	375	2.00
		855	770	570	455	2.50
		1 005	905	670	535	3.00
		1 065	960	710	560	3.20
6 PR	97 A6 (89 A8)	795	715	530	425	2.00
		930	835	620	495	2.50
		1 060	950	705	565	3.00
		1 095	985	730	580	3.20
6 PR	103 A6 (96 A8)	880	790	585	470	1.50
		1 050	945	700	560	2.00
		1 215	1 095	810	650	2.50
		1 315	1 180	875	710	2.80
6 PR	103 A6 (96 A8)	880	790	585	470	1.50
		1 050	945	700	560	2.00
		1 215	1 095	810	650	2.50
		1 315	1 180	875	710	2.80



B 11



B 15



V-5501



V-5501A

Bantam tires

For light agricultural equipment and hand trucks

Tire size	Tread pattern	Ply rating PR	Service description LI/SS	Type	Rim (permitted)	Tube Flap	Section width (mm)	Overall diameter (mm)	Tire load capacity (kg)	Tire pressure (bar)	Speed (km/h)
3.50-6	B 15	4 PR	45 A6	TT	2.50×6	4.00-6	96	343	165	3.00	30
3.50-6	B 15 Ribbed	4 PR	49 A6	TT	2.50×6	4.00-6	100	343	185	2.50	30
4.00-6	V-5501	4 PR	54 A6	TT	3.00×6	4.00-6	114	374	212	2.50	30
4.00-6	V-5501	6 PR	63 A6	TT	3.00×6	4.00-6	114	374	272	3.50	30
4.00-6	B 11	6 PR	59 A6	TT	2.50×6	3.50/4.00-6	109	367	243	4.25	30
3.50-8	B 11	4 PR	49 A6	TT	2.50×8	3.50/4.00-8	98	400	185	3.00	30
3.50-8	B 15	4 PR	49 A6	TT	2.50×6	3.50/4.00-8	96	388	185	3.00	30
3.50-8	V-5501	4 PR	48 A6	TT	2.50×8	3.50/4.00-8	100	393	180	2.50	30
4.00-8	V-5501B	2 PR	45 A6	TT	3.00×8	3.50/4.00-8	112	418	165	2.10	30
4.00-8	V-5501A	4 PR	55 A6	TT	3.00×8	3.50/4.00-8	112	418	218	2.50	30
4.00-8	B 11	4 PR	57 A6	TT	3.00×8	3.50/4.00-8	109	410	230	2.75	30

These tires are for normal agricultural use and not for continuous highway service.
TT = Tube Type



Tread pattern marking TRA – United States

Production name	TRA Marking
HC 1000	R-1
HC 2000	R-1W
HC 3000	R-1W
HC 3000 R	R-1W
SFT (SFT N)	R-1W
SST	R-1W
HC 70	R-1W
AC 65 (AC 65 N)	R-1W
AC 70 T	R-1W
AC 70 G	R-1
AC 75 G	R-1W
AC 70 H	R-1W
AC 70 N	R-1W
AC 85	R-1W
AC 85 Row Crop	R-1
AC 90 Row Crop	R-1
AR-01	I-3 / HF-2
AR-02	I-3 / HF-2
AR-03	I-3 / HF-2
AR-04	I-3 / HF-2
AR-05	I-3 / HF-2
AR-06	I-3 / HF-2
AGRITERRA 02	I-3 / HF-2
AGRITERRA 03	I-3 / HF-3
AGRITERRA 04	I-3 / HF-3
HCM	R-4
TI-20	R-4
MPT-01	R-1W
MPT-22	R-4
AC 70 +	R-1
TI-05	R-4
AF-01	R-1
TL-01	R-1
TD-01	R-1
TD-02	R-1
TD-05	R-1
TD-08	R-1
TD-10	R-1
TD-13	R-1
TD-17	R-1
TD-19	R-1

Production name	TRA Marking
IM-01	I-3
IM-02	I-3
IM-03	I-1
IM-04	I-1
IM-07	I-1
IM-09	I-2
IM-10	I-1
B 3	I-3
B 11	I-1
B 15	I-1
B 15 Ribbet	I-1
B 19	I-1
B 63	I-1
G 1	I-3
AC 30	I-3
V-5501 (A, B)	I-1
TR-01	R-1
TR-03	R-4
TR-04	R-4
TR-05	R-4
TR-06	I-3
TR-07	I-3
TR-08	I-3 / HF-2
TR-10	R-4
TR-11	R-4
TR-12	R-4
TS-02	R-1
TS-04	R-1
TS-05	R-1
TS-06	R-1
TS-07	R-1
B 12	R-1
B 16	R-1
B 17	R-1
B 18	R-1
B 64	R-1
TF-01	F-2
TF-02	F-2
TF-03	F-2
TF-04	F-2
IM-05	F-3

Use and maintenance

Storage

- > Keep the tires clean and away from heat, light, ozone or hydrocarbon sources.
- > Avoid prolonged exposure of the tires to direct sunlight.
- > Avoid any contact with grease, petrol, volatile solvents or other substances that may deteriorate the rubber.
- > Avoid horizontal storage for tubeless tires, only small size tires may be stacked or stored flat (maximum 6 months).
- > When tires are stored flat (horizontal), the position must be lug against lug.
- > Reduce inflation pressure when tires are stored fitted on rims.
- > Ensure there is no water or moisture inside the tire.
- > Never store tires directly in contact with the ground for long periods.

Tire repairs

- > For safety reasons, repairs should only be carried out by specialists using the correct tools.

Proper use of tires

- > When loading tires you have to consider the correlation between speed, inflation pressure and load capacity.
- > Overloading results in premature tire failure. Use the technical documentation and inflation tables which show the load and pressure figures for different operating speeds.
- > Underinflation results not only in incorrect tread wear but also in ply separation and eventually further damage to the ply.
- > Overinflation makes the tire stiff and decreases its resistance against hits, leading to ply tear.



Check inflation pressure regularly.



Avoid contact with grease, oil and other chemicals.



Inspect tires for damage and irregularities.



Observe tire and vehicle load limits.



Read safety and maintenance recommendations.



Use only authorised repair.

Fitting and removal instructions

Demounting and mounting procedures can be dangerous, and should be performed only by trained and qualified staff, using proper tools and procedures. Failure to comply with these procedures may result in faulty positioning of the tire on the rim, and cause the tire to burst with explosive force leading to serious physical injury or death.

Fitting

1. Make sure that the rim, the tire and the tube are compatible.
2. Check that the tire is suitable for the machine. Use only rims recommended or permitted by the tire manufacturer.
3. Always use the proper specialised equipment and tools.
4. The rim must be clean and in perfect condition (no damage, etc.). If necessary, clean the rim thoroughly with a wire brush. Never fit a tire onto a rim that shows cracks, significant distortion, evidence of welded repair, etc.
5. Thoroughly inspect the inside as well as the outside of the tire in order to identify any damage which may be present. If the damage is considered to be beyond repair, the tire should be scrapped.
6. If fitting with a tube, always use the correct new tube and flap for the tire size. For fitting tubeless tires without tubes, on tubeless rims, always use a new tubeless valve.
7. Before fitting, lubricate the rim and the beads. Use only a suitable lubricant that will not damage the tire (never use silicone or petroleum-based products).
8. We recommend vertical fitting. In case of horizontal fitting it is impossible to see if the lower bead is correctly seated.
9. Fit the tire on the rim diametrically opposite to the valve hole (respect, if present, the rotation direction indicated by the arrows). With the help of a suitable lever and closely repeated applications, get the first bead over the rim flange. Then pose the lightly inflated talc coated tube (if fitted) inside the tire. Locate the valve, fitting the ferrule loosely. Fit the second bead, lever it progressively over the rim flange, finish at the valve.
10. For seating the beads and centring of the tire, remove the valve core. Slowly inflate to ensure correct seating of the beads. Ensure that the beads do not pinch the tube.
11. During tire inflation keep at a safe distance and always use a safety cage. If possible, fasten the tire to the wall or use retaining chains. During pressure readings ensure that no part of the body is within the possible trajectory of the valve mechanism or of the caps. It is recommended to use suitable pressure limitation gauges. Use a filter and dehumidifier on the compressed air line to avoid introducing humidity or dirt. Never use a hammer to make a tire bead seat by hitting it.
12. Continue inflation. Make sure that you do not inflate beyond 2.5 bar if the beads are not well seated and centred on the wheel.
13. If the beads are not correctly seated, deflate, lubricate and inflate again. Repeat these operations until the beads are correctly seated.
14. When all the previous operations have been correctly done refit the valve core. Set the pressure according to the load – see tables in technical databook.
15. Make sure the valves do not touch the rims, the brake drums or other fixed mechanical parts.

Removing

- > Never try to unseat the beads of an inflated tire.
- > Always remove the valve core.
- > Let the tire deflate, check before unseating that the tire is completely deflated. Never use tools that could damage the rims or the beads of the tire.

Liquid ballasting of tractor tires

In some cases, it is necessary to add weight to tires to increase traction power. Filling the tire with a liquid (water) is a simple and inexpensive way. It is possible to add liquid to the tires up to 75% of their volume. In winter, to avoid the water damaging the tires when it freezes, suitable quantities of anti-freeze must be added.

Instructions for adding liquid

1. Jack the wheel up and position the valve at the highest vertical point.
2. Unscrew the removable valve body from the valve and connect a combined air-water fill and draining valve to the valve chunk. Air can be removed from the tire through this valve while the water is entering.
3. Introduce the water or anti-freeze mixture into the tire. Stop filling when liquid starts to issue from the valve. The quantity of liquid added will be about 75%. Do not over-fill!
4. Replace the valve body and inflate the tire to the recommended operating pressure.
5. Clean all metal parts – anti-freeze solution is corrosive.

Instructions for draining liquid

1. Jack the wheel up and position the valve at the lowest vertical point.
2. Unscrew the valve core and let the water drain out.
3. Attach a small rubber hose of suitable length to the locking washer and insert the hose into the tire tube, then screw the washer down over the stem of the valve.
4. Inflate the tire with air.
5. Remove the internal valve stem and let the remaining water drain from the tire.
6. Remove the rubber hose and reassemble the valve. Inflate with air up to the recommended pressure.

Anti-freeze solution

- > As protection against frost, it is recommended to add Calcium Chloride (CaCl_2). If a tubeless tire is mounted, we recommend that the rim should be treated against corrosion or an inner tube must be used.
- > Remember – prepare the solution by pouring the Calcium Chloride into the water, stirring to help it dissolve. Never pour water on to Calcium Chloride, it is dangerous.

CaCl_2 per litre of water	Protection to
200 g	-10 °C
250 g	-15 °C
300 g	-20 °C
350 g	-25 °C
400 g	-30 °C

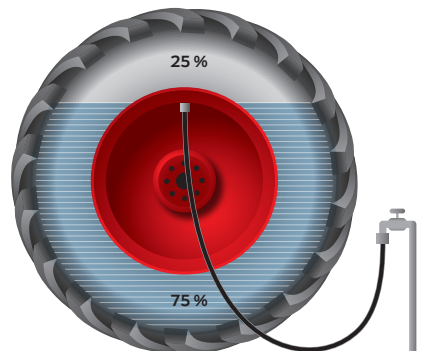

Liquid ballasting of tractor tires

Quantity when approx. 75 % full

Inch	Tire size (Alternative tire size)	Tread pattern	Liquid (l)
16"	200/70 R 16	AC 70 T	35
	240/70 R 16	AC 70 T	40
	260/70 R 16	AC 70 T	45
	265/70 R 16 MPT	AC 70 G	45
	280/70 R 16	AC 70 T	50
	285/80 R 16 MPT	AC 70 G	60
	320/65 R 16	AC 65	65
17"	425/55 R 17 MPT	AC 70 G	95
18"	280/70 R 18	AC 70 T	55
	325/70 R 18 MPT	AC 70 G	82
	365/70 R 18 MPT	AC 70 G	105
20"	260/70 R 20	AC 70 T	52
	275/80 R 20 MPT	AC 70 G	65
	280/70 R 20	AC 70 T	60
	280/85 R 20 (11.2 R 20)	AC 85	65
	300/70 R 20	AC 70 T	70
	320/70 R 20	AC 70 T	80
	335/80 R 20 MPT	AC 70 G	105
	360/70 R 20	AC 70 T	115
	375/70 R 20 MPT	AC 70 G	120
	380/70 R 20	AC 70 T	120
	405/70 R 20 MPT	AC 70 G	140
	420/65 R 20	AC 65	145
	425/75 R 20 MPT	AC 70 G	150
22.5"	445/65 R 22.5 MPT	AC 70 +	170
24"	280/85 R 24 (11.2 R 24)	AC 85	85
	320/70 R 24	HC 70	100
	320/70 R 24	AC 70 T	100
	320/85 R 24 (12.4 R 24)	AC 85	115
	340/85 R 24 (13.6 R 24)	AC 85	140
	360/70 R 24	HC 70	125
	360/70 R 24	AC 70 T	125
	380/70 R 24	HC 70	145
	380/70 R 24	AC 70 T	145

Inch	Tire size (Alternative tire size)	Tread pattern	Liquid (l)
20"	380/70 R 24	AC 70 G	145
	380/85 R 24 (14.9 R 24)	AC 85	185
	405/70 R 24 MPT	AC 70 G	155
	420/70 R 24	HC 70	170
	420/70 R 24	AC 70 T	170
	420/70 R 24	AC 70 G	170
	420/85 R 24 (16.9 R 24)	AC 85	240
	440/65 R 24	AC 65	185
	440/80 R 24 IND	HCM	230
	445/70 R 24 MPT	AC 70 G	205
	460/70 R 24 IMP	AC 70 G	220
	480/65 R 24	AC 65	210
	480/70 R 24	HC 70	225
	480/70 R 24	AC 70 G	225
	495/70 R 24 MPT	AC 70 G	240
	500/70 R 24 IMP	AC 70 G	245
	500/85 R 24 IMP	SFT	310
540/65 R 24	AC 65	300	
25"	1000/50 R 25	SFT	1080
26"	620/75 R 26	SFT	505
	750/65 R 26	SFT	600
28"	280/85 R 28 (11.2 R 28)	AC 85	100
	320/85 R 28 (12.4 R 28)	AC 85	130
	340/85 R 28 (13.6 R 28)	AC 85	160
	380/70 R 28	HC 70	165
	380/70 R 28	AC 70 T	165
	380/85 R 28 (14.9 R 28)	AC 85	205
	400/80 R 28 IND	HCM	205
	420/70 R 28	HC 70	200
	420/70 R 28	AC 70 T	200
	420/70 R 28	AC 70 G	200
VF 420/85 R 28 (16.9 R 28)	HC 2000	250	
420/85 R 28 (16.9 R 28)	AC 85	250	
440/65 R 28	AC 65	200	

Inch	Tire size (Alternative tire size)	Tread pattern	Liquid (l)
	440/70 R 28 IND	AC 70 G	215
	440/80 R 28 IND	HCM	255
	480/65 R 28	AC 65	250
	480/70 R 28	HC 70	260
	480/70 R 28	AC 70 T	260
	500/80 R 28 IMP	SFT	350
	540/65 R 28	SFT	315
	540/65 R 28	AC 65	315
	600/65 R 28	SFT	400
	600/65 R 28	AC 65	400
	600/65 R 28 IMP	AC 65	400
	600/70 R 28	SFT	490
30"	380/85 R 30 (14.9 R 30)	AC 85	220
	420/70 R 30	HC 70	225
	420/70 R 30	AC 70 T	225
	420/85 R 30 (16.9 R 30)	AC 85	270
	420/90 R 30	AC 85	285
	460/85 R 30 (18.4 R 30)	AC 85	340
	480/70 R 30	HC 70	275
	480/70 R 30	AC 70 T	275
	480/70 R 30	AC 70 G	275
	500/85 R 30 IMP	SFT	390
	VF 600/70 R 30	HC 2000	490
	540/65 R 30	SFT	330
	540/65 R 30	AC 65	330
	540/65 R 30 IMP	AC 65	330
	600/65 R 30	AC 65	430
	VF 600/70 R 30	HC 2000	490
	600/70 R 30	SFT	490
	620/70 R 30 IMP	SFT	495
	620/70 R 30 IMP	SFT N	495
	620/75 R 30	SFT	550
	620/75 R 30 IMP	SFT	550
	710/55 R 30	SFT	520

Inch	Tire size (Alternative tire size)	Tread pattern	Liquid (l)
	710/60 R 30	SFT	550
	710/60 R 30 IMP	SFT	550
	710/65 R 30 IMP	SFT	630
	750/55 R 30	SFT	500
32"	270/80 R 32	AC 90	100
	270/95 R 32	AC 85	115
	320/85 R 32 (12.4 R 32)	AC 85	140
	320/90 R 32	AC 85	150
	650/75 R 32	AC 70 N	700
	650/75 R 32	AC 75 G	700
	650/75 R 32	AC 70 G	700
	680/85 R 32 CHO	AC 70 G	950
	680/85 R 32	AC 70 G	950
	800/65 R 32	AC 70 H	900
	800/65 R 32	AC 70 N	900
	800/70 R 32 CHO	SFT	1000
	800/70 R 32	SFT	1000
	900/60 R 32 CHO	SFT	1030
	900/60 R 32	SFT	1030
	900/70 R 32 CHO	SFT	1200
	900/70 R 32	SFT	1200
	1050/50 R 32	SFT	1280
	1250/50 R 32	SFT	1500
34"	320/85 R 34	AC 85	205
	VF 380/85 R 34 (14.9 R 34)	HC 2000	240
	380/85 R 34 (14.9 R 34)	AC 85	240
	420/85 R 34 (16.9 R 34)	AC 85	290
	460/85 R 34 (18.4 R 34)	AC 85	380
	480/70 R 34	HC 70	310
	480/70 R 34	AC 70 T	310
	480/70 R 34	AC 70 G	310
	500/85 R 34 IMP	SFT	445
	520/70 R 34	HC 70	335
	520/70 R 34	AC 70 T	335

Liquid ballasting of tractor tires

Quantity when approx. 75 % full

Inch	Tire size (Alternative tire size)	Tread pattern	Liquid (l)
	520/70 R 34	AC 70 G	335
	540/65 R 34	AC 65	360
	600/65 R 34	AC 65	465
	650/60 R 34	SFT	540
	650/65 R 34	SFT	600
	710/60 R 34	SFT	660
36"	270/80 R 36	AC 90	115
38"	320/85 R 38 (12.4 R 38)	AC 85	205
	340/85 R 38 (13.6 R 38)	AC 85	215
	380/80 R 38 (14.9 R 38)	AC 85	240
	VF 380/95 R 38	HC 2000	280
	380/95 R 38	AC 85	280
	420/85 R 38 (16.9 R 38)	AC 85	320
	460/85 R 38 (18.4 R 38)	AC 85	420
	480/70 R 38	HC 70	340
	480/70 R 38	AC 70 T	340
	480/80 R 38 IND	HCM	385
	520/70 R 38	HC 70	395
	520/70 R 38	AC 70 T	395
	520/70 R 38	AC 70 G	395
	520/85 R 38 (20.8 R 38)	AC 85	530
	540/65 R 38	AC 65	420
	540/80 R 38 IND	HCM	505
	580/70 R 38	HC 70	550
	580/70 R 38	AC 70 T	550
	600/65 R 38	SST	500
	600/65 R 38	AC 65	500
	650/65 R 38	SFT	630
	650/65 R 38	SST	630
	650/65 R 38	AC 65	630
	650/75 R 38	SFT	750
	650/85 R 38	SFT	900
	680/80 R 38 CHO	SFT	865
	710/70 R 38	SFT	800

Inch	Tire size (Alternative tire size)	Tread pattern	Liquid (l)
	710/70 R 38	AC 65	800
	800/70 R 38 CHO	SFT	1100
	800/70 R 38	SFT	1100
	900/60 R 38 CHO	SFT	1200
	900/60 R 38	SFT	1200
42"	300/85 R 42 (11.2 R 42)	AC 90	140
	300/95 R 42 (12.4 R 42)	AC 90	185
	480/80 R 42	AC 85	460
	VF 520/85 R 42	HC 2000	580
	VF 520/85 R 42 CFO	HC 3000	580
	520/85 R 42 (20.8 R 42)	AC 85	580
	VF 580/85 R 42 CFO	HC 3000	645
	580/85 R 42	SFT	645
	VF 650/65 R 42	HC 2000	650
	650/65 R 42	SST	650
	650/65 R 42	AC 65	650
	650/75 R 42	SFT	740
	680/80 R 42 CHO	SFT	1020
	680/80 R 42	SFT	1020
	VF 710/70 R 42	HC 2000	880
	VF 710/70 R 42 CFO	HC 3000	880
	710/70 R 42	SFT	880
	710/75 R 42	SFT	950
	800/70 R 42 CHO	SFT	1135
	900/60 R 42	SFT	1320
	900/60 R 42 CHO	SFT	1320
46"	320/95 R 46	AC 85	215
	VF 380/90 R 46	HC 1000	330
	380/90 R 46	AC 85	330
	VF 480/80 R 46	HC 2000	500
	480/80 R 46	AC 85	500
	520/85 R 46 (20.8 R 46)	AC 85	620
	710/65 R 46	SFT	925
	IF 710/65 R 46	SFT	925

Inch	Tire size (Alternative tire size)	Tread pattern	Liquid (l)
48"	270/95 R 48	AC 90	150
	340/90 R 48 (13.6 R 48)	AC 85	230
50"	320/90 R 50	AC 85	245
	380/90 R 50	AC 85	360
	VF 380/105 R 50	HC 1000	395
	480/80 R 50	AC 85	550
	VF 480/95 R 50	HC 2000	650
	480/95 R 50	AC 85	650
	54"	320/90 R 54	AC 85
380/90 R 54		AC 85	345
VF 380/105 R 54		HC 2000	414
380/105 R 54		AC 85	414

Tire size diagonal tires	Liquid (l)
8.3 - 20	45
8.3 - 24	50
9.5 - 24	60
11.2 - 24	70
12.4 - 24	80
13.6 - 24	120
14.9 - 24	150
16.9 - 24	210
18.4 - 26	305
23.1 - 26	470
11.2 - 28	90
12.4 - 28	110
13.6 - 28	140
14.9 - 28	180
16.9 - 28	220
16.9 - 30	240
18.4 - 30	320
16.9 - 34	250
18.4 - 34	330
12.4 - 36	150
12.4 - 38	170
13.6 - 38	190
14.9 - 38	220
15.5 - 38	245
16.9 - 38	280
18.4 - 38	370

Explanations referring to tractor tires

Tables on page 28 to 107, 166 to 177 and 206 to 209

Load capacity and speed

When determining the minimum tire size necessary for a vehicle, the approved axle load and the maximum design speed of the vehicle should always be used as the basis.

Nominal load capacity = 100 % load, as indicated by the Load Index (LI), see page 13.

In the case of twin-fitted driven wheels, a factor of 1.76 is applied to the load capacity of a single-fitted tire.

Tire pressure

The tire pressures given in the tables are minimum tire pressures and should be used as a guide only.

The given max. air pressures may not be exceeded. All tire pressures refer to the “cold” tire which has been standing outdoors for several hours, not exposed to intense sunlight.

For twin fitments of radial tires on tractors (to minimise ground pressure) a min. tire pressure of 0.4 bar is allowed.

The Static Loaded Radius is the distance between centre of wheel and paved ground measured at reference load and pressure.

The Rolling Circumference (at reference load and reference pressure) is the distance a tire covers with one revolution on paved surface. Measurement acc. to ISO 11795.

The Speed Radius Index (SRI) is by convention a parameter used exclusively for calculation of theoretical speed of tractors. In no case SRI can be used as measurable value of rolling circumference.

Instead of W or W...L rims, the same size in DW or DWW may be used if the flange height is the same. (Designation of rims see pages 224.)

Old	Temporary	New	In millimetres
8	8.3/8	8.3	
9	9.5/9	9.5	240
10	11.2/10	11.2	280
11	12.4/11	12.4	320
12	13.6/12	13.6	340
13	14.9/13	14.9	380

Old	Temporary	New	In millimetres
14	16.9/14	16.9	420
15	18.4/15	18.4	460
16	20.8/16	20.8	520
18	23.1/18	23.1	
Sample			
13-28	14.9/13-28	14.9-28	380/85-28

Variation in load capacity with speed dependence

Tractor radial & diagonal

Speed (km/h)	0	5	10	15	20	25	30	35
Speed category A6	+130%	+70%	+40%	+30%	+20%	+7%	(0)	-10%
A8	+130%	+70%	+50%	+34%	+23%	+11%	+7%	+3%
D	+130%	+70%	+40%	+34%	+23%	+18.5%	+15%	+12%

Speed (km/h)	40	45	50	55	60	65	70
Speed category A6	-20%	-	-	-	-	-	-
A8	(0)	-4%	-9%	-	-	-	-
D	+9.5%	+7%	+5%	+3%	+1.5%	(0)	-9%

All Field Applications:

A6 Tires – loads as in the Table

A8 Tires – loads as in the Table plus 7%

The Inflation Pressure must be increased for:

- road transport and long-distance transport with semi-trailer +0.3 bar
- harvesting machines and front-end loader tractor application +0.4 bar

Tractor Front – steering wheels

Speed (km/h)	10 *	15	20	25	30	35	40	45
Speed category A6	+50%	+43%	+35%	+15%	(0)	-10%	-20%	
A8	+67%	+50%	+39%	+28%	+11%	+4%	(0)	-7%

* Basic Inflation Pressure must be increased about 25%.

If a front-end loader is fitted on the tractor, +100% applies.

Explanations referring to IMP tires

Tables on page 110 to 135 and 180 to 203

IMP = Implement tires

Load capacity and speed

When determining the minimum tire size necessary for a vehicle, the approved axle load and the maximum design speed of the vehicle should always be used as the basis.

Nominal load capacity = 100 % load, as indicated by the Load Index (LI), see page 13.

Tire pressure

The tire pressures given in the tables are minimum tire pressures and should be used as a guide only. The given max. air pressures may not be exceeded.

All tire pressures refer to a "cold" tire which has been standing outdoors for several hours, not exposed to intense sunlight.

The static radius is for the new tire laden at the max. load capacity and at the corresponding tire pressure as per the table concerned.

The rolling circumference corresponds to the max. load capacity (100%) and is inflated at the corresponding tire pressure as per the table concerned. At 50% of the max. load capacity the rolling circumference is increased by approx. 1% for a radial tire and by approx. 1.8% for a cross-ply tire on the drive wheel of an agricultural tractor.

Rims. Only the rims indicated in this data book are approved for fitting to new vehicle series.

⊙ drive wheel

⊙→ free rolling wheel

Variation in load capacity with speed dependence

AR-01, AR-02

Speed (km/h)		0	5	10	15	20	25	30	35	40
Speed category	D	+95%	+87%	+75%	+60%	+50%	+40%	+35%	+30%	+24%
	F	+150%	+110%	+80%	+65%	+50%	+35%	+25%	+19%	+15%

Speed (km/h)		45	50	55	60	65	70	75	80
Speed category	D	+17%	+11%	+7%	+3%	(0)	–	–	–
	F	+13%	+12%	+11%	+10%	+7.5%	+5%	+2.5%	(0)

Agriterra 02, Agriterra 03 & Agriterra 04

Speed (km/h)		0	5	10	15	20	25	30	35	40
Speed category	D	+130%	–	+80%	+73%	+65%	+58%	+51%	+44%	+36%

Speed (km/h)		45	50	55	60	65	70	75	80
Speed category	D	+29%	+21%	+14%	+7%	(0)	–	–	–

Implement, Implement Traction, Tractor small – Free rolling

Speed (km/h)		0	10	15	20	25	30	35	40	45	50
A6 (30 km/h)	LLV	+65%	+29%	+21%	+14%	+7%	(0)	-5%	-10%	–	–
	HLV	+98%	+55%	+45%	+37%	+28%	+20%	+14%	+8%	–	–
A8 (40 km/h)	LLV	+65%	+40%	+33%	+26%	+19%	+12%	+5%	(0)	-5%	-10%
	HLV	+98%	+68%	+60%	+51%	+43%	+34%	+26%	+20%	+14%	+8%

Implement, Implement Traction, Tractor small – Drive wheels

Speed (km/h)		0	10	15	20	25	30	35	40	45	50
A6 (30 km/h)	LLV	+135%	+29%	+21%	+14%	+7%	(0)	-5%	-10%	–	–
	HLV	+193%	+84%	+73%	+63%	+53%	+43%	+36%	+29%	–	–
A8 (40 km/h)	LLV	+135%	+40%	+33%	+26%	+19%	+12%	+5%	(0)	-5%	-10%
	HLV	+193%	+100%	+90%	+80%	+70%	+60%	+50%	+43%	+36%	+29%

LLV = Low Load Variation

HLV = High Load Variation, is where the tire load varies by a factor of "2" or more between loaded and unloaded conditions.

The inflation pressure for HLV application must be increased, consult tire manufacturer.

In the case of HLV, the maximum distance should not exceed 1 km. For a longer distance, consult tire manufacturer.

Terms and abbreviations used in this catalogue

Acronyms	Meaning	Definition
PR	Ply Rating	Identifies different versions (load capacity/inflation pressure) of tires having the same size designation.
TYPE	Tubeless or Tube Type	Tubeless (TL) – Tires specifically designed for fitment without an inner tube on appropriate rims. Tubeless tires may be used with a tube.
LI	Load Index	Is a numerical code associated with the maximum load a tire can carry at the speed indicated by its Speed Symbol under service conditions specified by the tire manufacturer.
SS	Speed Symbol	Indicated the maximum speed at which the tire can carry a load corresponding to its Load Index under service conditions specified the tire manufacturer.
	Free Rolling Wheels	Free rolling wheels, that not transmit motion, e.g. trailer
	Drive Wheels	Drive wheels, that transmit motion, e.g. drive wheel axle on tractors
RIM	Recommended Rim	The rim which gives the best fitment of the tire for all conditions and types of service.
RIM (PERMITTED)	Permitted Rim	Any rim which can be permitted in addition to the recommended rim.
	New Tire Dimensions	The dimensions of an unloaded new tire mounted on its Measuring Rim at the recommended inflation pressure and allowed to stand for a minimum of 24 hours at normal room temperature before readjustment of the pressure back to its original level.
	Section Width (design)	The linear distance between the outsides of the sidewalls of an inflated new tire excluding elevations due to labelling (marking), decorations, or protective bands or ribs.
	Overall Diameter (design)	The diameter of an inflated tire at the outermost surface of the tread.
	Static Radius (theoretical nominal)	The radius of the new tire loaded at the maximum load capacity and with the corresponding tire pressure.
	Rolling Circumference (theoretical nominal)	The circumference of the tire loaded at the maximum load capacity and with the corresponding tire pressure.

Acronyms	Meaning	Definition
LOAD CAPACITY	Tire Load Carrying Capacity	The maximum load (kg) a tire is permitted to carry under specified operating conditions. In the case of twin-fitted driven wheels, a factor of 1.76 is applied to the load capacity of a single fitment tire.
	Inflation Pressure	The “cold” pressure (bar) of the fluid with which the tire is inflated.
HLV	High Load Variation	Is where the tire load varies by a factor of “2” or more between loaded and unloaded conditions. The inflation pressure for HLV application must be increased, consult tire manufacturer. In the case of HLV, the maximum distance should not exceed 1 km and maximum speed 10 km/h. For a longer distance or higher speed, consult tire manufacturer. Example of purpose: without HLV – normal use with constant load in transport service, on tractor in field service, e.g. trailer, tractor; with HLV – use with various load conditions, factor > 2 between loaded and unloaded, e.g. loaders
LLV	Low Load Variation	Standard application with low load difference between loaded and unloaded conditions.
WATER 75%	Capacity of Water	Capacity of water for Water balasting.
ETRTO	The European Tire and Rim Technical Organisation	Data in this Technical Databook are relevant with ETRTO standards, the further data you can find there.
SRI	Speed Radius Index	The Speed Radius Index is by convention a parameter used exclusively for the calculation of the theoretical speed of tractors during European Union homologation procedures and for interchangeability of different tire sizes.
	Nominal Section Width	The section width of an inflated tire mounted on its theoretical rim and indicated in the tire size designation.
IND		Agricultural tires for traction wheels for construction applications with load capacities and inflation pressures which differ from those for tires which the same size designation for use on agricultural tractors.
REINFORCED		Tires with better protection against tire damage (puncture). The load capacity and tire dimensions stay like standard execution.

Mitas

mitas-tires.com



Discover our website



Discover our mobile app



Follow us

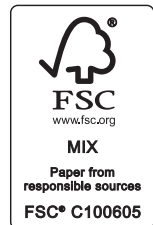

© Yokohama TY&S 6/23_1 | Subject to technical amendments, printing errors and mistakes in text or illustrations.

Mitas